



Video Projector



MDLP2 Owner's Manual

The lightning flash with arrowhead, within an equilateral triangle, is intended to alert the user to the presence of uninsulated “dangerous voltage” within the product’s enclosure that may be of sufficient magnitude to constitute a risk of electric shock to persons.



AVIS RISQUE DE CHOC ELECTRIQUE - NE PAS OUVRIR.

The exclamation point within an equilateral triangle is intended to alert the user to the presence of important operating and maintenance (servicing) instructions in the literature accompanying the appliance.

WARNING - TO REDUCE RISK OF FIRE OR ELECTRICAL SHOCK, DO NOT EXPOSE THIS EQUIPMENT TO RAIN OR MOISTURE.

NO USER-SERVICEABLE PARTS INSIDE. REFER SERVICING TO QUALIFIED PERSONNEL.

To prevent the risk of electric shock, do not remove cover or back. No user-serviceable parts inside.

IMPORTANT SAFETY INSTRUCTIONS!

PLEASE READ THEM BEFORE OPERATING THIS EQUIPMENT.

1. Read these instructions.
2. Keep these instructions.
3. Heed all warnings.
4. Follow all instructions.
5. Do not use this apparatus near water.
6. Clean only with a dry cloth.
7. Do not block any ventilation openings. Install in accordance with the manufacturer’s instructions.
8. Do not install near any heat sources such as radiators, heat registers, stoves, or other apparatus (including amplifiers) that produce heat.
9. Do not defeat the safety purpose of the polarized or grounding-type plug. A polarized plug has two blades with one wider than the other. A grounding type plug has two blades and a third grounding prong. The wide blade or the third prong are provided for your safety. If the provided plug does not fit into your outlet, consult an electrician for replacement of the obsolete outlet.
10. Protect the power cord from being walked on or pinched particularly at plugs, convenience receptacles, and the point where they exit from the apparatus.
11. Only use attachments/accessories specified by the manufacturer.
12. Use only with the cart, stand, tripod, bracket, or table specified by the manufacturer, or sold with the apparatus. When a cart is used, use caution when moving the cart/apparatus combination to avoid injury from tip-over. 
13. Unplug this apparatus during lightning storms or when unused for long periods of time.
14. Refer all servicing to qualified service personnel. Servicing is required when the apparatus has been damaged in any way, such as power-supply cord or plug is damaged, liquid has been spilled or objects have fallen into the apparatus, the apparatus has been exposed to rain or moisture, does not operate normally, or has been dropped.
15. Do not expose this equipment to dripping or splashing and ensure that no objects filled with liquids, such as vases, are placed on the equipment.
16. To completely disconnect this equipment from the a.c. mains, disconnect the power supply cord plug from the a.c. receptacle.
17. The mains plug of the power supply cord shall remain readily operable.
18. Do not expose batteries to excessive heat such as sunshine, fire or the like.

ADDITIONAL SAFETY INSTRUCTIONS!

CAUTION:

The MDLP2 Video Projector weight is 40 pounds (18.14 kilograms). When mounting the projector to a building structure it is important to follow all of the local building/construction codes. Not evaluated for Wall or Ceiling Mounting.

WARNINGS:

- Do not remove the cover from the equipment.
- Do not insert anything into the equipment through the ventilation holes.
- Do not handle the mains lead with wet hands.
- No naked flame sources, such as lighted candles, should be placed on the equipment.
- When disposing of used batteries and the projector lamp, please comply with governmental regulations or environmental public instructions rules that apply in your country or area.
- Do not look into the lens when the projector is turned on. It could damage your eyesight.

LAMP HANDLING PRECAUTIONS:

DANGER

This projector uses a high voltage glass mercury vapor lamp. The lamp can break or fail to light when improperly handled, operating at abnormal temperatures or after extended use.

Lamp life also varies, and operating the lamp beyond its intended service life may cause it to break or fail to light properly, with risk of resulting damage to the projector or surrounding property or persons. Do not exceed the stated lamp life, nor attempt to override

the projector's lamp life timing system. The mercury vapor gas inside the lamp bulb may be emitted from the projector's vent.

Before use, carefully read the projector Owner's Manual and the lamp replacement instructions. Remember to handle the lamp with care. In the event of serious trouble, call a McIntosh Authorized Dealer.

- Do not directly expose skin to the light of the lamp as it can cause inflammation.
- Do not drop, impact, subject to excessive force or otherwise damage the lamp.
- Replacing the lamp runs the risk of burns, cuts and electric shock, unplug the AC power cord from the AC power outlet and wait at least 60 minutes for the lamp to cool down before attempting to replace it.
- If the lamp breaks and the projector is hung from a ceiling or installed in a high place, unplug the AC power cord from the AC power outlet and call a McIntosh Authorized Dealer for assistance.
- It is recommended to replace the lamp when near the end of its designed life. Do not use the lamp beyond the maximum lighting time.
- Replace the defective lamp with a genuine McIntosh Lamp, matching the information in this Owner's Manual.
- Before replacing the lamp, carefully read the Lamp Replacement Instructions in this Owner's Manual and the instructions supplied with the replacement lamp.
- If the lamp breaks, leave the area immediately and stay away for at least 30 minutes. Ventilate the room, so as not to inhale the mercury vapor. If you inhale the mercury vapor, see a physician immediately.

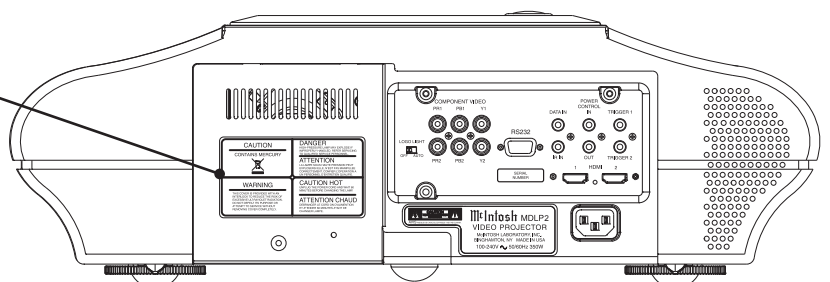
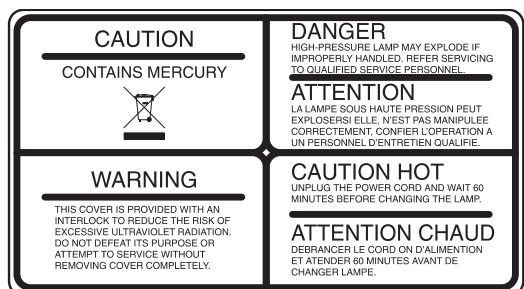



Thank You

Your decision to own this McIntosh MDLP2 Video Projector ranks you at the very top among discriminating video viewers. You now have “The Best.” The McIntosh dedication to “Quality,” is assurance that you will receive many years of viewing enjoyment from this unit.

Please take a short time to read the information in this manual. We want you to be as familiar as possible with all the features and functions of your new McIntosh.

Please Take A Moment

The serial number, purchase date and McIntosh Dealer name are important to you for possible insurance claim or future service. The spaces below have been provided for you to record that information:

Serial Number: _____

Purchase Date: _____

Dealer Name: _____

Technical Assistance

If at any time you have questions about your McIntosh product, contact your McIntosh Dealer who is familiar with your McIntosh equipment and any other brands that may be part of your system. If you or your Dealer wish additional help concerning a suspected problem, you can receive technical assistance for all McIntosh products at:

McIntosh Laboratory, Inc.
2 Chambers Street
Binghamton, New York 13903
Phone: 607-723-1545
Fax: 607-724-0549

Customer Service

If it is determined that your McIntosh product is in need of repair, you can return it to your Dealer. You can also return it to the McIntosh Laboratory Service Department. For assistance on factory repair return procedure, contact the McIntosh Service Department at:



McIntosh Laboratory, Inc.
2 Chambers Street
Binghamton, New York 13903
Phone: 607-723-3515
Fax: 607-723-1917

Table of Contents

Safety Instructions	2
Thank You and Please Take a Moment.....	4
Technical Assistance and Customer Service	4
Table of Contents	4
General Information	5
Connector and Cable Information	6
Introduction.....	7
Performance Features	7
Dimensions	8
Installation:	
Overview.....	9
Ventilation.....	9
Projector and 16:9 Screen Mounting Location	10
Projector and 4:3 Screen Mounting Location	12
Initial Setup.....	14
Connections:	
Rear Panel Connections.....	16
How to Connect the MDLP2	17
Connection Diagrams (Separate Sheet).....	Mc2A,Mc2B
Remote Control:	
Remote Control Push-buttons.....	18
How to Operate by Remote Control	19
Operation:	
Front Panel Push-buttons, Indicators and Control	20
Default Settings.....	21
How to Operate the MDLP2	22
Additional Information:	
Specifications.....	30
Packing Instruction.....	31

General Information

CAUTION: To prevent possible damage to the Projector Lens Assembly, DO NOT at any time attempt to LIFT, CARRY or RE-ORIENT the Projector using the Lens.

1. The Main AC Power going to the MDLP2 and any other McIntosh Component(s) should not be applied until all the system components are connected together. Failure to do so could result in malfunctioning of some or all of the system's normal operations. When the MDLP2 and other McIntosh Components are in their Standby Power Off Mode, the Microprocessor's Circuitry inside each component is active and communication is occurring between them.
2. For additional connection information, refer to the owner's manual(s) for any component(s) connected to the MDLP2 Video Projector.
3. To protect the Projector Lens from possible damage, it is advisable to keep the Lens Cover on the Projector during the following:
 - a. Transporting of the projector.
 - b. Installation and connection of the projector.
 - c. During the installation of other items and/or remodeling of the room where the projector is located.
4. The Projector Lens is a precision optical device with special coatings just like you would find on Professional Cameras. In the event the Lens requires cleaning to remove airborne particles such as dust and dirt from the Lens, use a safe cleaning product such as a clean and dry 3M™ Scotch-Brite® Microfiber Lens Cleaning Cloth. At no time should ordinary household cleaning products be used to clean the Lens, as damage will occur.
5. A McIntosh Power Controller may be added to the MDLP2 to provide AC Power Switching to components without Power Control Connections, such as a motorized projection screen. See your McIntosh Dealer for additional information.
6. The IR Input, with 1/8 inch mini phone jack, is configured for non-McIntosh IR sensors such as a Xantech Model 291-80 or equivalent. To avoid possible interaction, the MDLP2 Sensors may be disabled by activating the On-Screen Menu, then select from the menu *Config*→*Remote Control*→*Wired*. Then deactivate the On-Screen Menu. Refer to the "How to Operate the MDLP2" starting on page 23.
7. The On-Screen Menu System for adjustment of settings is interactive and Video Input type based, make sure to select the desired Video Input and Picture Mode before attempting to change the settings.
8. The MDLP2 has two Component Video Inputs for analog video signals and two HDMI Inputs for Digital video signals. The On-Screen Menu System has selections for Composite Video, S-Video and RGB Inputs. Those inputs have no functionality when selected on the MDLP2.
9. When discarding the unit, comply with local rules or regulations. Batteries should never be thrown away or incinerated but disposed of in accordance with the local regulations concerning battery disposal. 
10. For additional information on the MDLP2 and other McIntosh Products please visit the McIntosh Web Site at www.mcintoshlabs.com. 



Connector and Cable Information

Power Control Connectors

The MDLP2 Power Control Output Jacks send and Power Control Input Jacks receive Power On/Off Signals when connected to McIntosh and other non-McIntosh Components. A 1/8 inch stereo mini phone plug is used for connection to the Power Control Input and Outputs on the MDLP2.

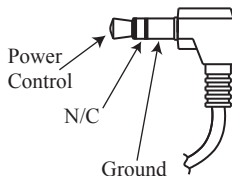

Note: The Data and Power Control Connecting Cable is available from the McIntosh Parts Department:

Data and Power Control Cable Part No. 170-202

Six foot, shielded 2 conductor, with 1/8 inch stereo mini phone plugs on each end.

Data Port Connectors

The MDLP2 Data In Port receives Remote Control Signals from other McIntosh Components. A 1/8 inch stereo mini phone plug is used for connection. The IR Ports also use a 1/8 inch stereo mini phone plug and allow the connection of other brand IR Receivers to the MDLP2.

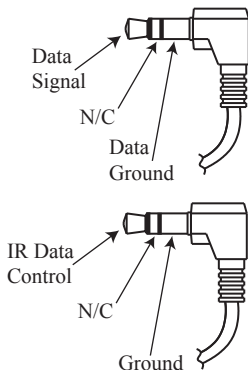

RS232 DB9 Connector Pin Layout

- | | |
|-------------------|--------|
| 1. N/C | 6. N/C |
| 2. Data Out (TXD) | 7. N/C |
| 3. Data In (RXD) | 8. N/C |
| 4. N/C | 9. N/C |
| 5. Gnd. | |

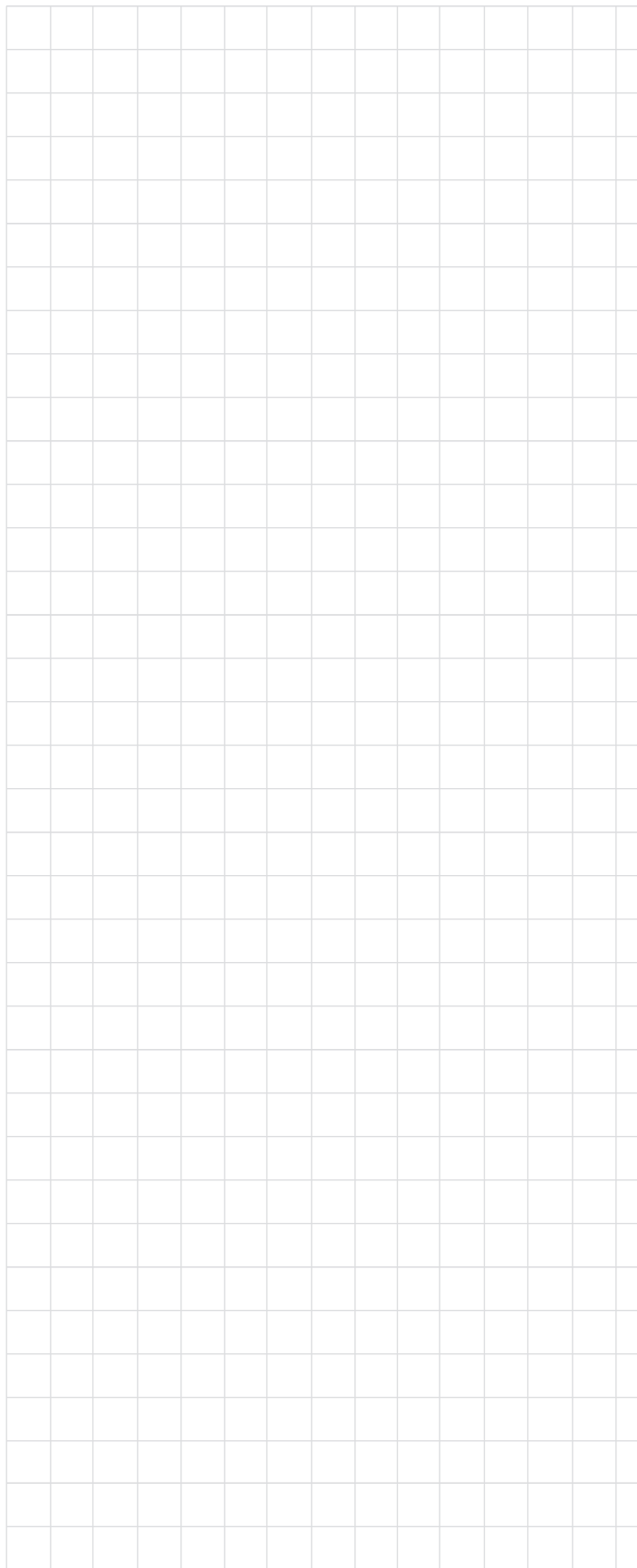
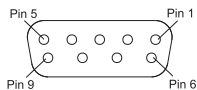

Introduction

The McIntosh MDLP2 Video Projector is one of the finest projectors ever created. It utilizes the latest Digital Micromirror Device™ containing over 2 million individual pixels (1080p) and produces images of such high quality, it's just like being there.

Performance Features

• DLP Chip

The McIntosh MDLP2 Video Projector incorporates the latest and largest available Digital Light Processing (DLP) Dark Chip for use in a Home Theater Projector. The large chip size is 0.95 inch and produces a High Definition Image of 1920 x 1080 pixels.

• Advanced Optical System

The light source for the projector is the industry's only 200 Watt DC Super High Pressure lamp assembly. This assures an image with even illumination, focused from edge to edge and accurate fully saturated colors. The light is filtered by a large 98mm 7-segment color wheel incorporating a Neutral Density Filter Segment for enhanced black levels during dark scenes. After the light is reflected by the DLP Chip, it is then precisely focused by a Konica-Minolta custom designed zoom lens. This lens is fully sealed and consists of 13 all-glass elements. The optics allow for screen sizes with 16:9 wide aspect ratio ranging from 70 to 250 inches for the Medium Throw Lens or 80 to 300 inches for the Long Throw Lens.

• Dual Iris

The MDLP2 incorporates an adjustable Dual Iris Optical Light Path. This provides images with bright vivid color and high contrast ratios.

• Advanced Filter Wheel Design

The color filter wheel spins at 10,800 RPM, making color breakup (rainbow effect) a thing of the past, along with three user speeds settings. The quiet filter wheel motor uses a Fluid Dynamic Bearing for silent and reliable operation.

• Placement Compensation

The MDLP2 Projector incorporates numerous adjustments, compensating for less than ideal projector/screen positioning.

• Enhanced Video Processing

The Video Circuitry uses the very latest in processing

Digital Micromirror Device, Digital Light Processing, DLP, DLP logo, and DLP Medallion logo are registered trademarks of Texas Instruments.

algorithms to produce an excellent image regardless of the video source, from 480i to 1080p. This includes the 1080/24p frame rate available from some video sources. Also there is a special direct pixel pass through mode when used with external Video Processors.

• Video Adjustments

The MDLP2 allows for adjustment of important image quality effecting parameters, such as Color Temperature, Gamma and Black Level. There are also user adjustments with the ability to store the settings for future recall, along with three preset modes.

• HDMI™ 1.3 Connectivity with improved Color

There are two HDMI (High-Definition Multimedia Interface) inputs accepting 1080p signals. The MDLP2 supports Deep Color™ (8bit, 10bit or 12bit signals) for reproduction of over one billion possible colors and x.v. Color™ (Color Space) can display any color viewable by the human eye.

• On-Screen Information Displays

The On-Screen Display indicates the Source Selection and Information about the source signal. The Menu Selections and Adjustments are also displayed on screen.

• Die Cast Internal Chassis

The MDLP2 die cast aluminum internal chassis assures the precise mechanical alignment of the entire hermetically sealed optical light path, which is necessary for a sharp, highly detailed and accurate color image. The die cast chassis also assures low operating noise and also helps to dissipate heat away from the sensitive internal components.

• Machined Top and Bottom Panels

The MDLP2 Top and Bottom Panels are machined from thick aluminum with a smooth black anodized finish.

• Special Power Supply

Fully regulated Power Supplies ensure stable noise free operation even though the power line varies.

• Fiber Optic Solid State Top Panel Illumination

The even illumination of the Top Panel is accomplished by the combination of a custom designed Fiber Optic Light Diffuser and an extra long life Light Emitting Diode (LED). The glass Top Panel ensures the pristine beauty of the MDLP2 will be retained for many years.

HDMI, the HDMI logo, High-Definition Multimedia Interface, Deep Color and x.v. Color are trademarks or registered trademarks of HDMI Licensing LLC.



Dimensions

The following dimensions can assist in determining the best location for your MDLP2. There is additional information on the next page pertaining to installing the MDLP2 into cabinets.

Front View of the MDLP2

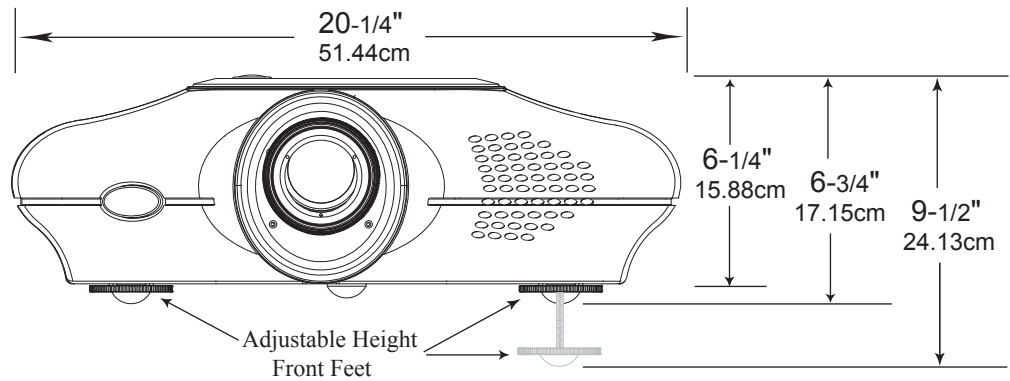

Rear View of the MDLP2

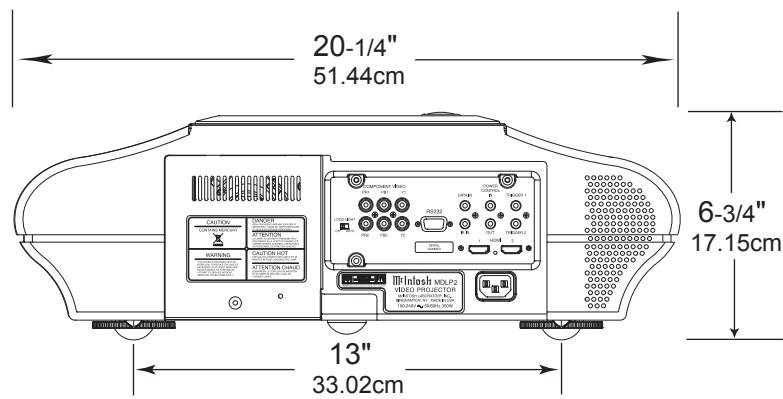

Side View of the MDLP2

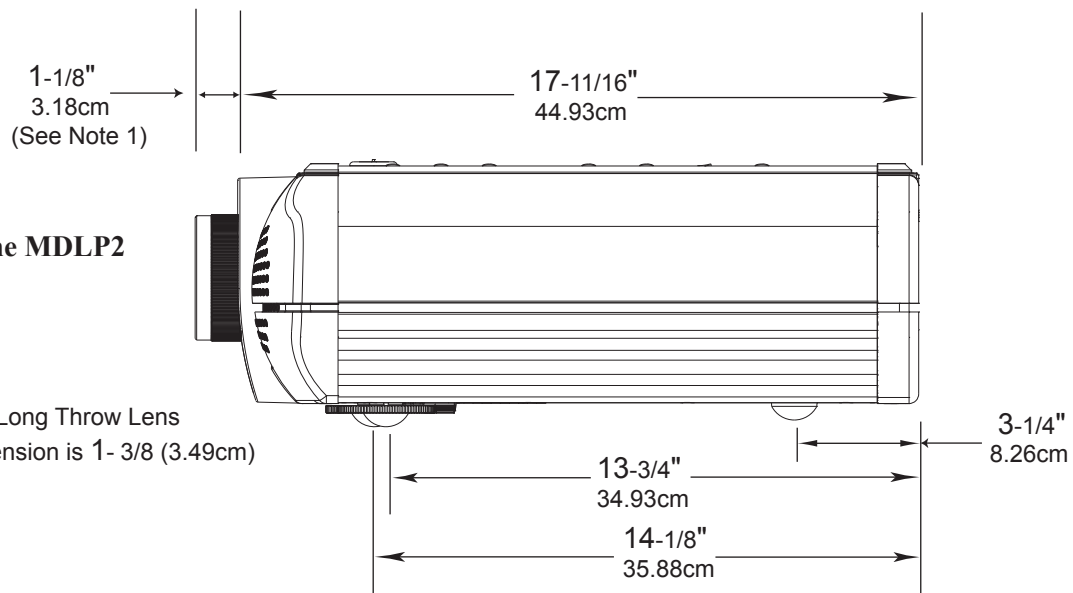

Note 1: The Long Throw Lens dimension is 1- 3/8 (3.49cm)

Installation Overview

For the best possible image reproduction by the McIntosh MDLP2 Video Projector, it is important to observe the following:

CAUTION: The MDLP2 Video Projector weight is 40 pounds (18.14 kilograms). When mounting the projector to a building structure it is important to follow all of the local building/constuction codes.

1. Decide on a viewing area with either subdued and/or controlled ambient lighting.
2. Choose a projector screen designed specifically to work with images from a DLP Projector.
3. Locate the position of the MDLP2 Projector relative to the projector screen to maximize image quality and minimize optical distortions.
4. Provide adequate ventilation.

The information below and on the following pages will assist in the location of the Projector. It is recommended that the Professionals at your McIntosh Dealer, who are skilled in all aspects of installation and operation, install the MDLP2 Video Projector and any associated audio/video equipment.

Ventilation

Always provide adequate ventilation for your MDLP2. Cool operation ensures the longest possible operating life for any electronic instrument. Do not install the MDLP2 directly above a heat generating component. Refer to figures 1 and 2.

The MDLP2 is designed to be placed upright on a solid flat surface, resting on its three feet with unrestricted air flow around it. Allow at least 1 foot (30.48 cm) of space between the Primary Warm Air Exit ventilation holes and the nearest wall or obstruction. There should be at least 3 inches (7.62 cm) between the Primary Cool Air Input ventilation holes and the nearest wall or obstruction. The ambient air temperature should not exceed 95°F (35°C).

The projector uses two primary and three secondary cool air input vents together with one primary warm air exit vent. Refer to the illustration on this page. The air flow in or out of these vents needs to be unrestricted at all times during operation.

In the event the MDLP2 is to be placed into an enclosure restricting air flow around the projector, some type of ducted forced air venting system would need to be implemented for the primary input 1 and 2 vents along with the primary exit vent.

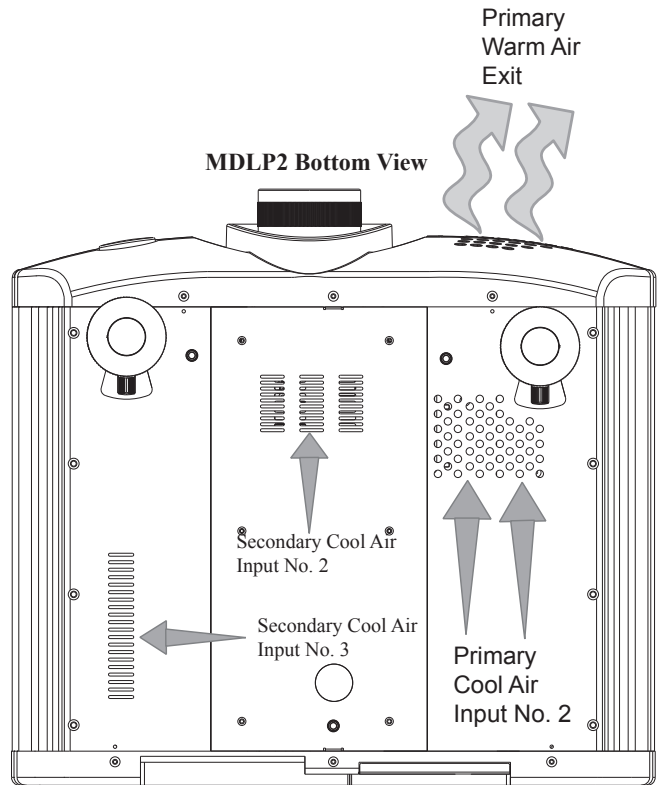

Figure 1

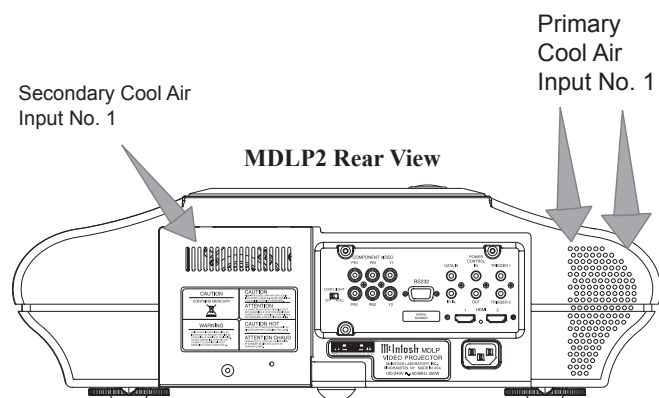

Figure 2



Projector and 16:9 Screen Mounting Location

The illustrations below together with the charts on the adjacent page, will help to assure the correct mounting locations for both the projector and the screen.

Projector mounted from the ceiling

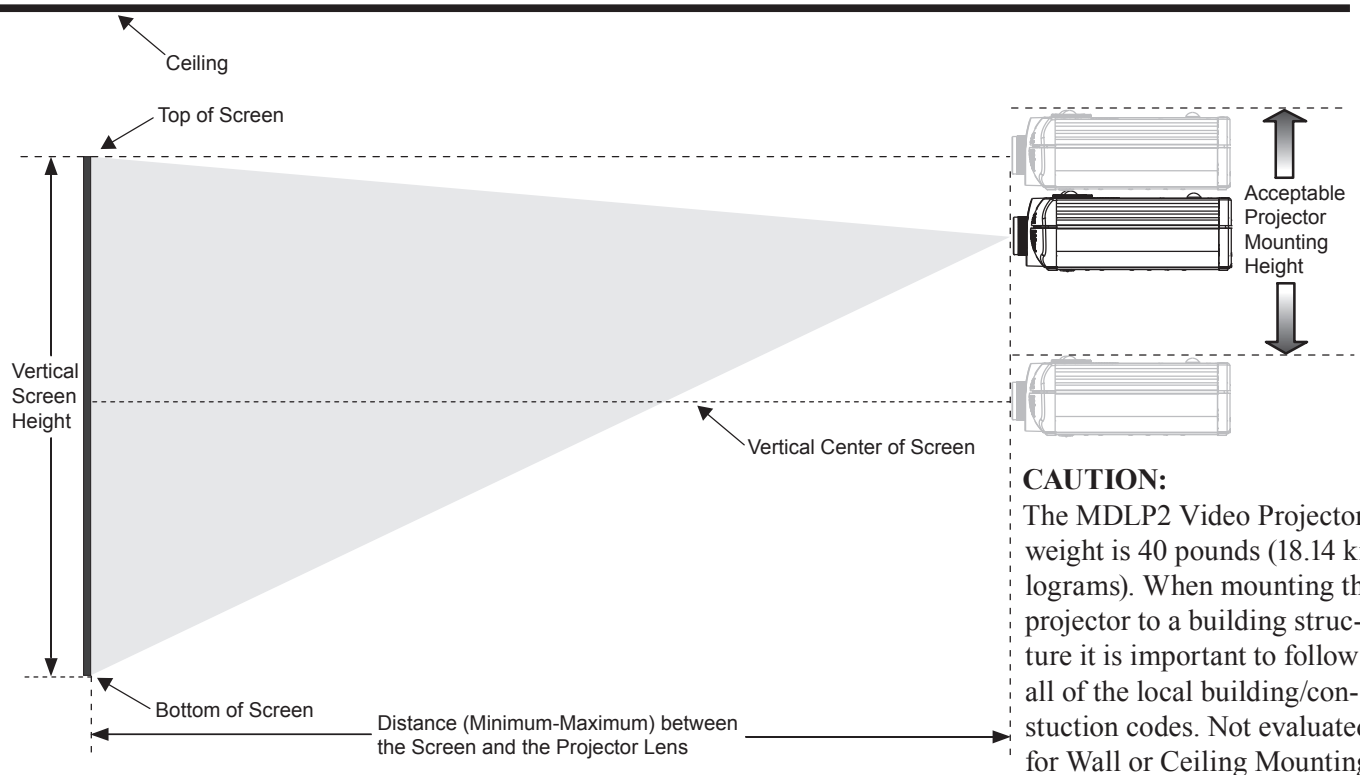

Projector placed above the floor

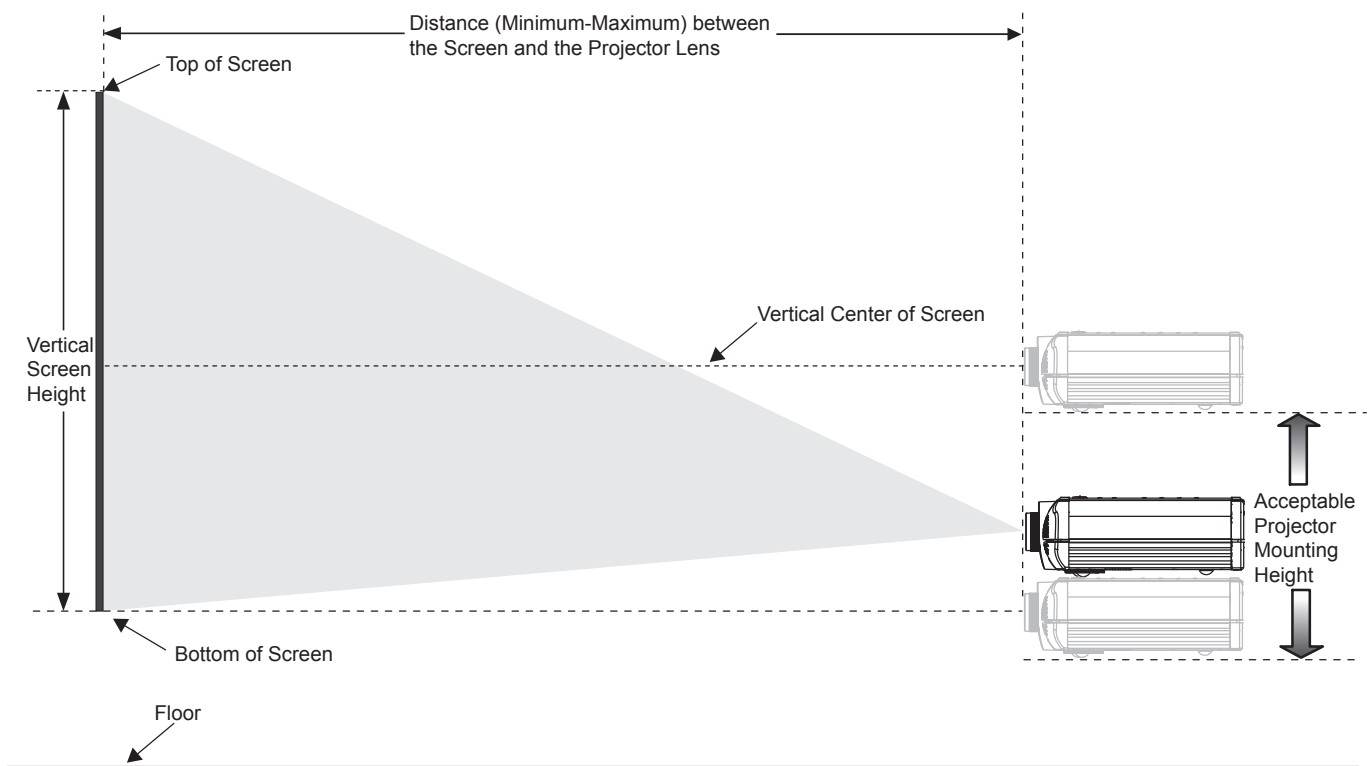

MDLP2M (with Medium Throw Lens) - 16:9 Screen Size (1.77:1 Aspect Ratio)									
Screen Diagonal		Screen Width		Screen Height		Minimum Distance		Maximum Distance	
Inches	Centimeters	Inches	Centimeters	Inches	Centimeters	Inches	Centimeters	Inches	Centimeters
70	177.8	61	155.0	34-5/16	87.2	88-6/16	224.3	129-1/16	327.6
72	182.9	62-12/16	159.4	35-5/16	89.7	90-15/16	230.8	132-13/16	337.1
80	203.2	69-12/16	177.1	39-4/16	99.0	101-5/16	257.1	147-13/16	375.1
82	208.3	71-8/16	181.5	40-3/16	102.1	103-14/16	263.6	151-9/16	384.6
84	213.4	73-3/16	186.0	41-3/16	104.6	106-7/16	270.2	155-5/16	394.1
90	228.6	78-7/16	199.2	44-2/16	112.1	114-3/16	289.9	166-8/16	422.6
92	233.7	80-3/16	203.7	45-2/16	114.6	116-13/16	296.4	170-4/16	432.1
100	254.0	87-3/16	221.4	49	124.5	127-2/16	322.7	185-4/16	470.1
106	269.2	92-6/16	234.7	51-15/16	132.0	134-14/16	342.3	196-7/16	498.6
110	279.4	95-14/16	243.5	53-15/16	137.0	140-1/16	355.5	203-15/16	517.6
120	304.8	104-9/16	265.7	58-13/16	149.4	153	388.3	222-11/16	565.1
123	312.42	107-3/16	272.3	60-5/16	153.2	156-14/16	398.1	228-4/16	579.4
133	337.8	115-15/16	294.4	65-3/16	165.6	169-12/16	430.9	247	626.9
135	342.9	117-11/16	298.9	66-3/16	168.1	172-6/16	437.5	250-12/16	636.4
150	381.0	130-12/16	332.1	73-9/16	186.8	191-12/16	486.7	278-13/16	707.6
170	431.8	148-3/16	376.3	83-6/16	211.7	217-9/16	552.3	316-4/16	802.6
200	508.0	174-5/16	442.8	98-1/16	249.1	256-6/16	650.7	372-6/16	945.1
250	635.0	217-14/16	553.5	122-9/16	311.3	321	814.7	465-15/16	1,182.6

MDLP2L (with Long Throw Lens) - 16:9 Screen Size (1.77:1 Aspect Ratio)									
Screen Diagonal		Screen Width		Screen Height		Minimum Distance		Maximum Distance	
Inches	Centimeters	Inches	Centimeters	Inches	Centimeters	Inches	Centimeters	Inches	Centimeters
80	203.2	69-12/16	177.1	39-4/16	99.6	147-3/16	373.5	222-3/16	564.0
82	208.3	71-8/16	181.5	40-3/16	102.1	150-15/16	383.0	227-13/16	578.2
84	213.4	73-3/16	186.0	41-3/16	104.6	154-10/16	392.5	233-7/16	592.5
90	228.6	78-7/16	199.2	44-2/16	112.1	165-14/16	421.0	250-5/16	635.3
92	233.7	80-3/16	203.7	45-2/16	114.6	169-10/16	430.5	255-15/16	649.5
100	254.0	87-3/16	221.4	49	124.5	184-10/16	468.5	278-6/16	706.6
106	269.2	92-6/16	234.7	51-15/16	132.0	195-13/16	497.0	295-4/16	749.3
110	279.4	95-14/16	243.5	53-15/16	137.0	203-5/16	516.0	306-8/16	777.9
120	304.8	104-9/16	265.7	58-13/16	149.4	222	563.5	334-9/16	849.2
123	312.42	107-3/16	272.3	60-5/16	153.2	227-10/16	577.8	343	870.6
133	337.8	115-15/16	294.4	65-3/16	165.6	246-6/16	625.3	371-1/16	941.9
135	342.9	117-11/16	298.9	66-3/16	168.1	250-2/16	634.8	376-11/16	956.1
150	381.0	130-12/16	332.1	73-9/16	186.8	278-3/16	706.0	418-14/16	1,063.1
170	431.8	148-3/16	376.3	83-6/16	211.7	315-10/16	801.0	475	1,205.7
200	508.0	174-5/16	442.8	98-1/16	249.1	371-12/16	943.5	559-5/16	1,419.6
250	635.0	217-14/16	553.5	122-9/16	311.3	465-5/16	1,181.0	699-12/16	1,776.1
300	762.0	261-8/16	664.1	147-1/16	373.6	558-14/16	1,418.5	840-4/16	2,132.6



Projector and 4:3 Screen Mounting Location

The illustrations below together with the charts on the adjacent page, will help to assure the correct mounting locations for both the projector and the screen.

Projector mounted from the ceiling

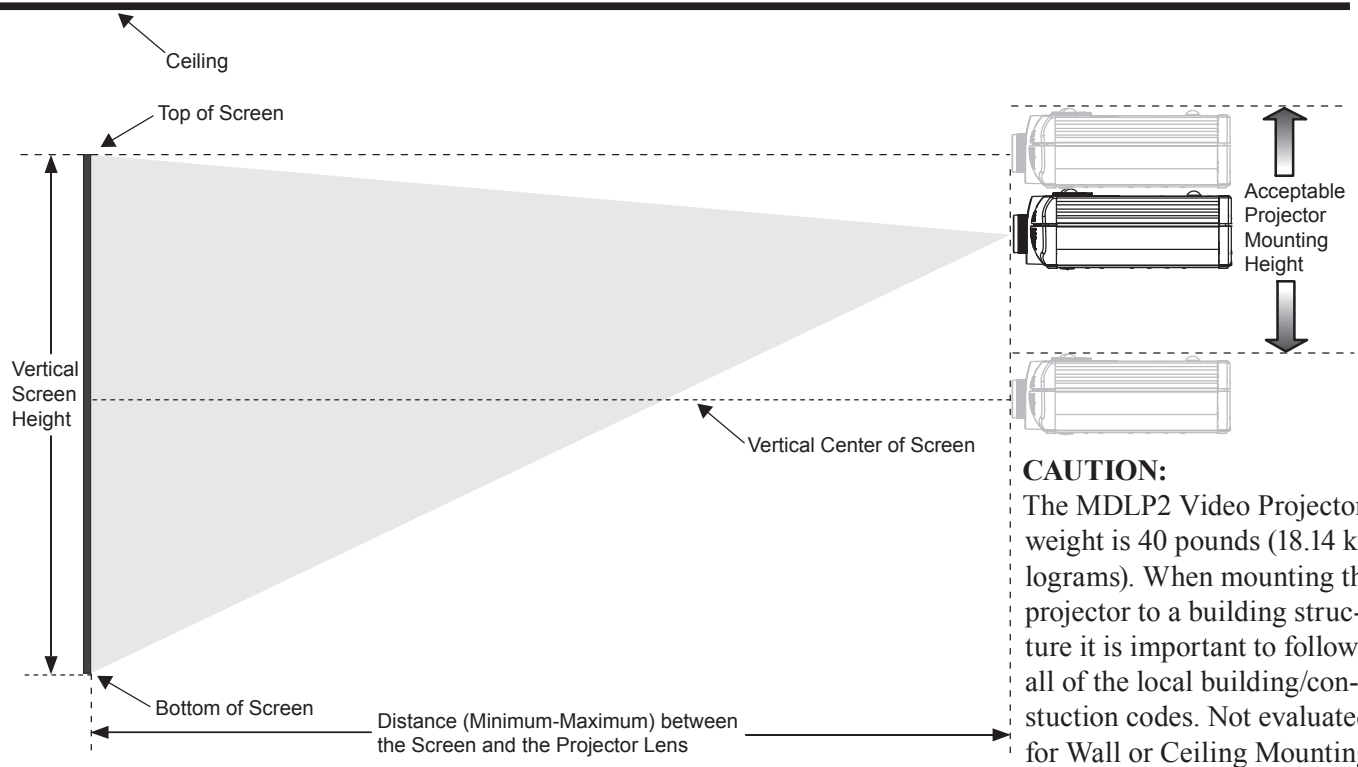

Projector placed above the floor

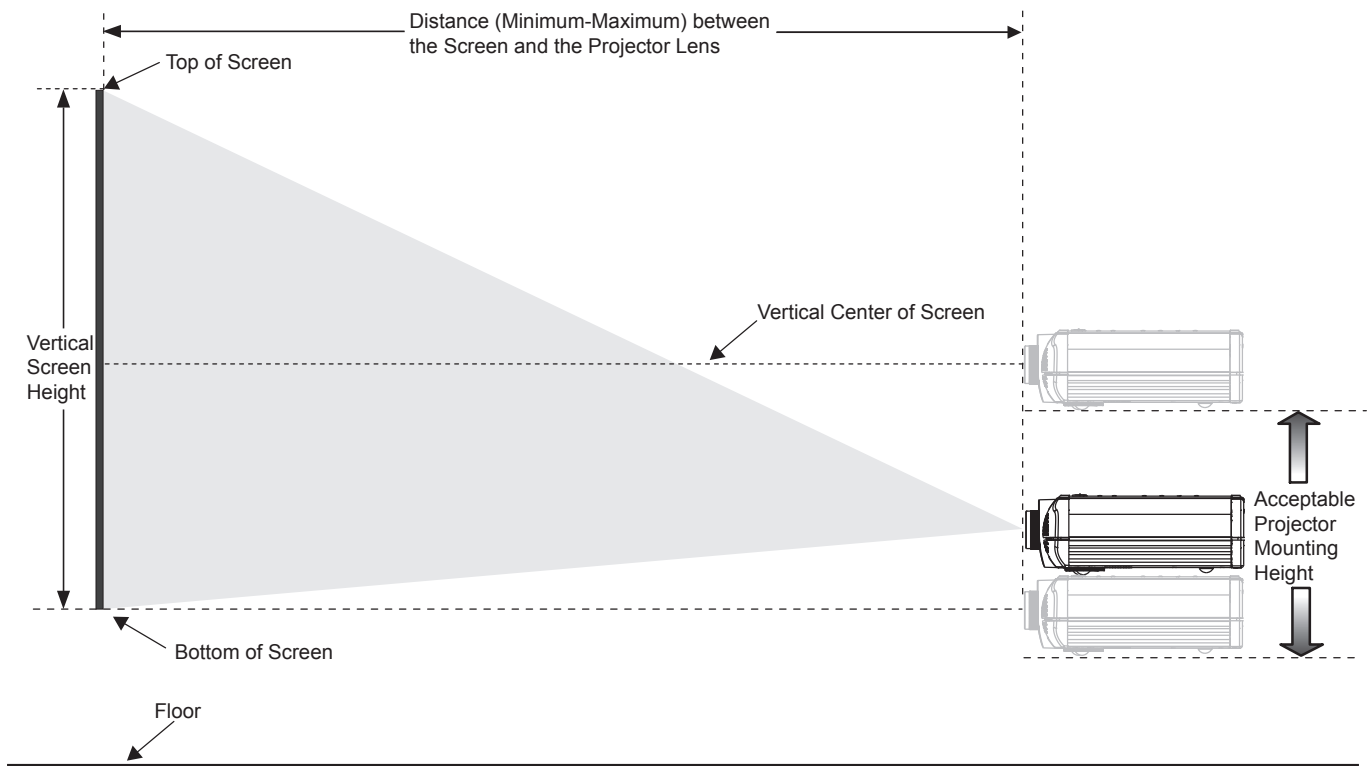

MDLP2M (with Medium Throw Lens) - 4:3 Screen Size (1.33:1 Aspect Ratio)									
Screen Diagonal		Screen Width		Screen Height		Minimum Distance		Maximum Distance	
Inches	Centimeters	Inches	Centimeters	Inches	Centimeters	Inches	Centimeters	Inches	Centimeters
70	177.8	56	142.2	42	106.7	108-8/16	275.4	158-5/16	401.8
72	182.9	57-10/16	146.3	43-3/16	109.7	111-10/16	283.4	162-14/16	413.4
80	203.2	64	162.6	48	121.9	124-5/16	315.5	181-3/16	459.9
82	208.3	65-10/16	166.6	49-3-16	125.0	127-7/16	323.5	185-13/16	471.5
84	213.4	67-3/16	170.7	50-6/16	128.0	130-10/16	331.5	190-6/16	483.2
90	228.6	72	182.9	54	137.2	140-1/16	355.6	204-2/16	518.0
92	233.7	73-10/16	186.9	55-3/16	140.2	143-4/16	363.6	208-11/16	529.6
100	254.0	80	203.2	60	152.4	155-14/16	395.7	227	576.1
106	269.2	84-13/16	215.4	63-10/16	161.5	165-6/16	419.7	240-12/16	611.0
110	279.4	88	223.5	66	167.6	171-11/16	435.8	249-14/16	634.2
120	304.8	96	243.8	72	182.9	187-8/16	475.9	272-12/16	692.3
123	312.42	98-6-16	249.9	73-13/16	187.5	192-4/16	487.9	279-10/16	709.8
133	337.8	106-6/16	270.3	79-13-16	202.7	208	528.0	302-9/16	767.9
135	342.9	108	274.3	81	205.7	211-3/16	536.0	307-2/16	779.5
150	381.0	120	304.8	90	228.6	234-14/16	596.2	341-7/16	866.6
170	431.8	136	345.4	102	259.1	266-8/16	676.4	387-4/16	982.8
200	508.0	160	406.4	120	304.8	313-14/16	796.7	455-14/16	1,157.1
250	635.0	200	508.0	150	381.0	392-14/16	997.2	570-6/16	1,447.6

MDLP2L (with Long Throw Lens) - 4:3 Screen Size (1.33:1 Aspect Ratio)									
Screen Diagonal		Screen Width		Screen Height		Minimum Distance		Maximum Distance	
Inches	Centimeters	Inches	Centimeters	Inches	Centimeters	Inches	Centimeters	Inches	Centimeters
60	152.4	48	121.9	36	91.4	203-13/16	517.4	203-13/16	517.4
70	177.8	56	142.2	42	106.7	157-11/16	400.2	238-4/16	604.7
72	182.9	57-10/16	146.3	43-3/16	109.7	162-4/16	411.8	245-2/16	622.1
80	203.2	64	162.6	48	121.9	180-9/16	458.3	272-10/16	692.0
82	208.3	65-10/16	166.6	49-3/16	125.0	185-3/16	469.9	279-8/16	709.4
84	213.4	67-3/16	170.7	50-6/16	128.0	189-12/16	481.6	286-6/16	726.9
90	228.6	72	182.9	54	137.2	203-8/16	516.4	307	779.3
92	233.7	73-10/16	186.9	55-3/16	140.2	208-1/16	528.0	313-15/16	796.7
100	254.0	80	203.2	60	152.4	226-6/16	574.5	341-7/16	866.6
106	269.2	84-13/16	215.4	63-10/16	161.5	240-2/16	609.4	362-1/16	918.9
110	279.4	88	223.5	66	167.6	249-4/16	632.6	375-13/16	953.9
120	304.8	96	243.8	72	182.9	272-2/16	690.7	410-3/16	1,041.2
123	312.42	98-6/16	249.9	73-13/16	187.5	279	708.2	420-9/16	1,067.4
133	337.8	106-6/16	270.3	79-13/16	202.7	301-14/16	766.3	454-15/16	1,154.7
135	342.9	108	274.3	81	205.7	306-8/16	777.9	461-13/16	1,172.1
150	381.0	120	304.8	90	228.6	340-13/16	865.0	513-6/16	1,303.1
170	431.8	136	345.4	102	259.1	386-10/16	981.2	582-3/16	1,477.7
200	508.0	160	406.4	120	304.8	455-4/16	1,155.5	685-6/16	1,739.6
250	635.0	200	508.0	150	381.0	569-12/16	1,446.0	857-6/16	2,176.1
300	762.0	240	609.6	180	457.2	684-3/16	1,736.5	1,029-6/16	2,612.6



Initial Setup

The Initial Setup Section is to assist with minimizing the possible geometric distortions in the projected image caused by the physical orientation of the MDLP2 Video Projector relative to the screen. While there are electronic adjustments to correct for some of these geometric distortions, the best images will be achieved when minimal electronic adjustments are used.

After the projector and screen locations have been established (refer to the four previous pages), the next step is to perform the basic optical and mechanical orientation adjustments as follows:

Note: Some installations might require location positional adjustments in addition to and/or in place of the projector's built-in adjustments.

1. Connect the projector to a live AC Outlet.
2. Remove the protective cover from the projector lens.
3. The Red LED to the left of the STANDBY/ON Push-button lights to indicate the MDLP2 is in Standby mode. To Switch ON the MDLP2, press the STANDBY/ON Push-button on the Projector Control Panel or the PROJECTOR ON Push-button using the Remote Control. The Green LED to the right of the STANDBY/ON Push-button lights to indicate the MDLP2 is ON. Refer to figures 3 and 4.

Note: It is normal for the projector lamp warm up period to last about a minute before an image appears on the screen.

4. Press the PATTERN Push-button on the Control Panel or the Remote Control. Refer to figures 3 and 4.

The Crosshatch Test Pattern (Horizontal and Vertical White Lines on a Black Background) will appear on the screen and will be used during the following steps. Refer to figures 5 and 6.

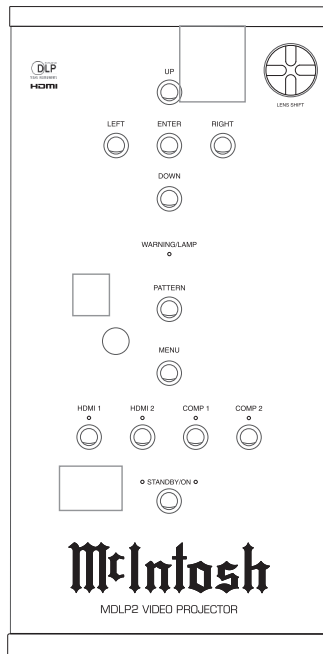

Figure 3

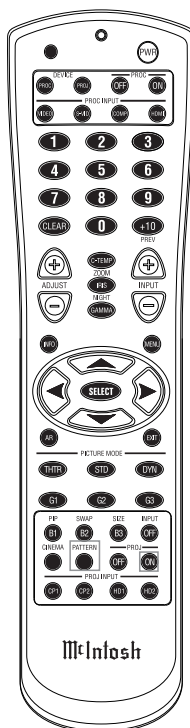

Figure 4

5. Rotate clockwise or counterclockwise the Knurled Ring surface on the front section of the projector lens to perform an initial focus adjustment. Refer to figures 5 and 6.

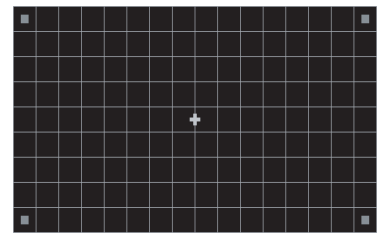

Figure 5

Note: Figure 6 is an example of an out of focus image. Do not be concerned at this time if the image doesn't fill the screen, is not centered and/or has geometric distortion.

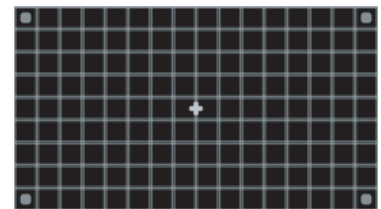

Figure 6

The next several adjustments will be performed to achieve the following:

- A. Fill the screen with the image.
 - B. Center the image both horizontally and vertically on the screen.
 - C. Minimize any horizontal keystone distortion of the image.
 - D. Orient the image to be parallel with the top, bottom and sides of the screen.
6. Rotate clockwise or counterclockwise the Knurled Ring surface on the rear section of the projector lens to fill the screen with the Crosshatch Test Pattern. Refer to figures 5 and 7.
 7. Move the entire projector slightly to the left or right to center the image horizontally on the screen.

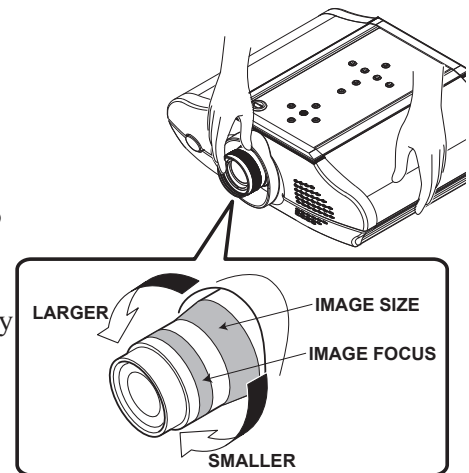

Figure 7

8. Using the LENS SHIFT Control, located on the Top Control Panel, center the image vertically on the screen. Refer to figures 3, 8 and 9.

Note: If the Crosshatch Test Pattern lines change in color from white to green, the current vertical height of the projector relative to the screen will not produce an acceptable image. Reposition either the projector or the screen vertically so when the image is

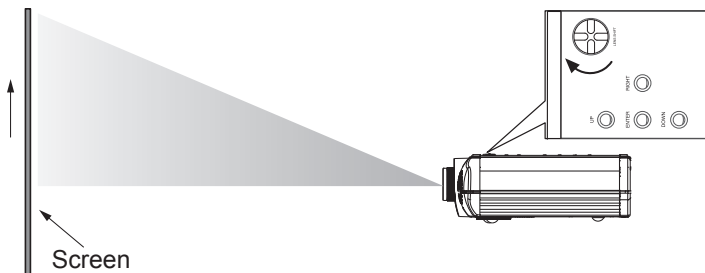

Figure 8

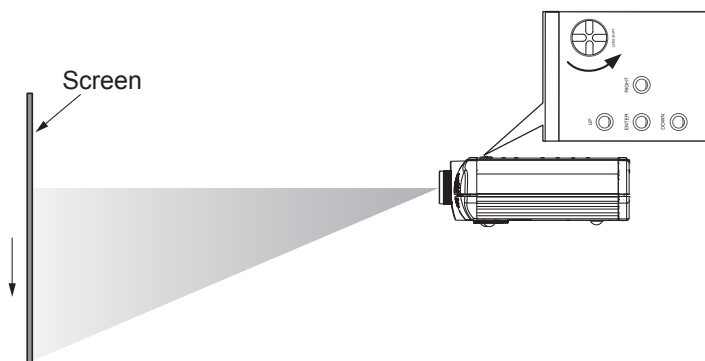

Figure 9

centered vertically on the screen the Crosshatch Test Pattern lines are again white in color.

9. Using the Knurled Ring surfaces on the projector lens, adjust the size and focus of the image. Refer to figure 7.
10. Rotate one or both of the projector feet to line up the top and bottom horizontal lines of the Crosshatch Test Pattern to be parallel with the top and bottom edges of the screen. Refer to figures 5 and 10.

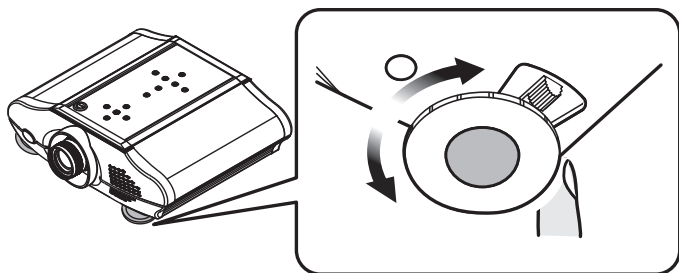

Figure 10

Note: If more than several turns are needed there is a release lever located next to the foot for rapid and large changes in height. Refer to figure 11.

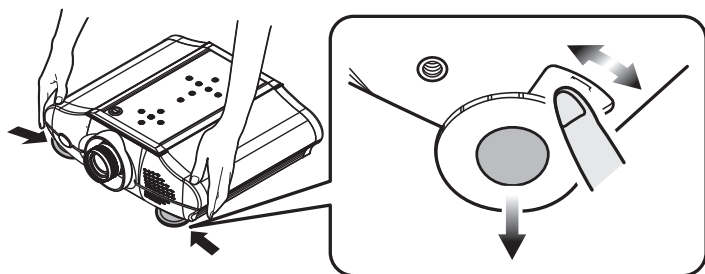

Figure 11

11. Using the Knurled Ring surfaces on the projector lens, adjust the size and focus of the image. Refer to figure 7.
12. Rotate the projector clockwise or counterclockwise about the center horizontal axis to minimize any horizontal keystone distortion. The top and bottom horizontal lines of the Crosshatch Test Pattern should be parallel with the top and bottom edges of the screen. Refer to figures 5, 12 and 13.

13. Using the knurled ring surfaces on the projector lens adjust the size and focus of the image. Refer to figure 7.
14. Repeat steps 6 thru 13 until no further improvements can be made.

Note: Correction for any vertical keystone distortion of the image will be performed later during the electronic setup adjustments on page 23.

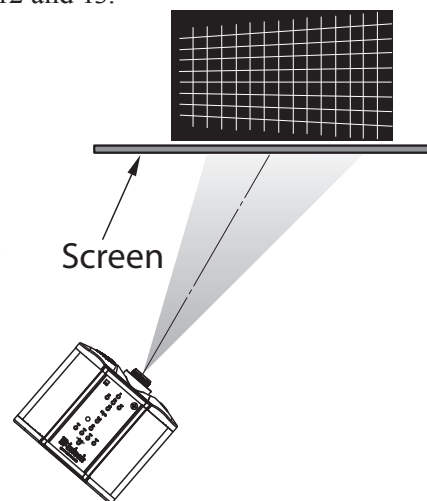

Figure 12

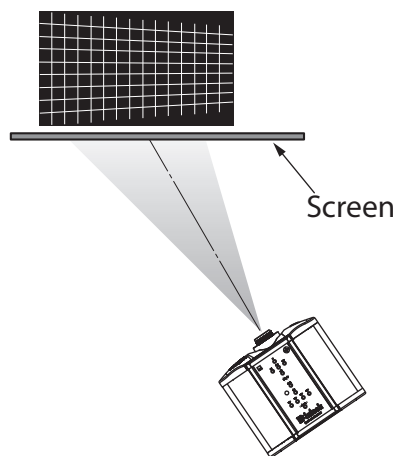

Figure 13

15. Press the STAND-BY/ON Push-button on the Projector Control Panel or the PROJ ON Push-button using the Remote Control.
16. Temporarily place the previously removed protective cover onto the projector lens.
17. Remove the AC Power Cord from the projector.
18. Proceed to the "How to connect the MDLP2" on page 17.



DATA IN Port receives signals from McIntosh A/V Control Center for Remote Control Operation

TRIGGER 1 Output sends a Turn-On signal to other components when the MDLP2 is switched On

COMPONENT INPUTS receive Component Video (Y, PR and PB) Signals from Component Video Sources

POWER CONTROL IN receives turn-on signals from a McIntosh component and POWER CONTROL OUT sends turn-on signals on to another McIntosh Component

TRIGGER 2 Output sends Turn-On signals to other components and may be assigned to activate when a specific aspect ratio is selected.

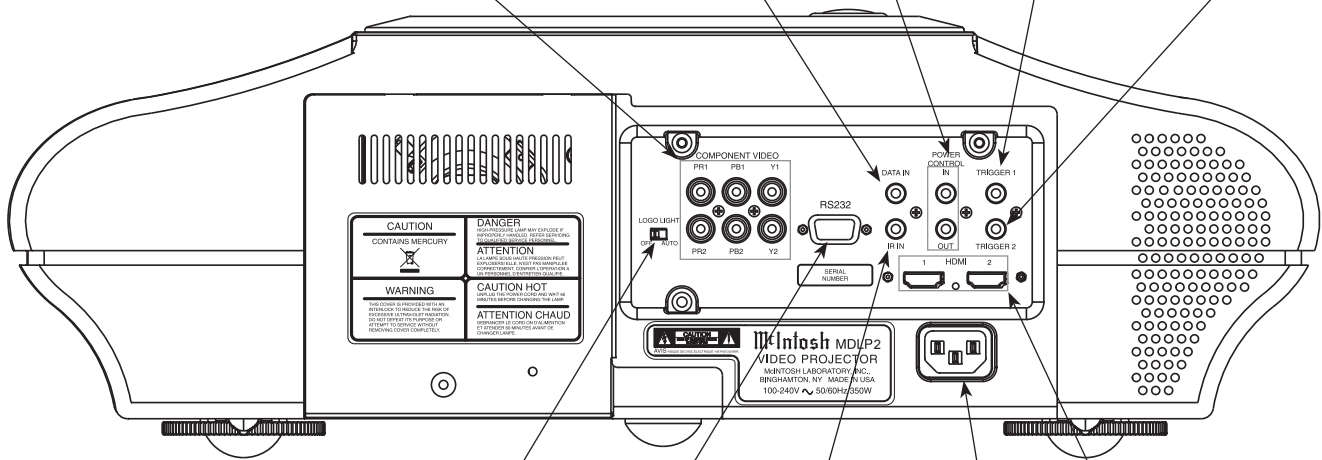

RS232 connector for connection to a computer or other control device

Connect the MDLP2 power cord to a live AC outlet. Refer to information on the back panel to determine the correct voltage

Switches Off the illumination to the Top Control Panel McIntosh Logo

IR INPUT for connecting an IR Receiver

HDMI Inputs receive digital video signals from a McIntosh A/V Control Center and/or other source components

How to Connect the MDLP2

The MDLP2 has the ability to automatically switch power On/Off to McIntosh Components via the Power Control and Trigger Connections. The Data Port Connections allow for the remote operation of the MDLP2 from other McIntosh Components. With an external sensor connected to the MDLP2, remote control operation is possible when the MDLP2 is located in an enclosure.

The connection instructions below, together with the AP1000/MDLP2/VP1000 Input and Control Connection Diagrams located on the separate folded sheet “Mc2A and Mc2B”, are an example of a typical audio/video system. Your system may vary from this; however, the actual components would be connected in a similar manner.

For additional information refer to “Connector and Cable Information” on page 6.

Note: With the addition of a McIntosh Power Controller connected to the MDLP2, AC Power Switching can be provided to components such as a motorized projection screen. Contact your McIntosh Dealer for additional information.

Power Control Connections:

1. Connect a Control Cable from the MDLP2 POWER CONTROL IN Jack to the Power Control Out A Jack on the McIntosh VP1000 Video Processor.

If the MDLP2 is connected to a McIntosh Audio/Video Control Center MX136, MX135, MX120, MX119, MX134 or MX132 (MX Series) add the following connection:

2. Connect a Control Cable from the MDLP2 POWER CONTROL IN A Jack to the McIntosh MX Series Power Control Zone A Out Jack.

Data Control Connections:

When the MDLP2 is connected to the McIntosh VP1000 Video Processor, no Data Port connection is necessary.

If the MDLP2 is connected to a McIntosh Audio/Video Control Center MX136, MX135, MX120, MX119, MX134 or MX132 (MX Series) add the following connection:

3. Connect a Control Cable from the MDLP2 DATA IN Jack to the McIntosh MX Series SUM A Data Port Jack.

Video Connections:

When the MDLP2 is connected to the McIntosh VP1000 Video Processor, add the following connections. If there is no VP1000, proceed to step 6.

4. Connect a Video Cable from the MDLP2 Y1, PB1 and PR1 COMPONENT VIDEO Input Jacks to the McIntosh VP1000 Component Video MON A Jacks.
5. Connect a Video Cable from the MDLP2 HDMI 1 Input Jack to the McIntosh VP1000 HDMI MON A Output Jack.

If the MDLP2 is connected to a McIntosh Audio/Video Control Center MX136, MX135, MX120, MX119, or MX134 (MX Series) add the following connection:

6. Connect a Video Cable from the MDLP2 Y1, PB1 and PR1 COMPONENT VIDEO Input Jacks to the McIntosh MX Series Component Video MON A Jacks.
7. Connect a Video Cable from the MDLP2 HDMI 1 Input Jack to the McIntosh MX Series HDMI MON A Output Jack.

Note: Only the MX136 and MX120 Audio/Video Control Centers will have a HDMI MON A Jack.

AC Power Cord Connections:

8. Connect the MDLP2 AC Power Cord to a live AC outlet.
9. Connect the remaining components' AC Power Cords.

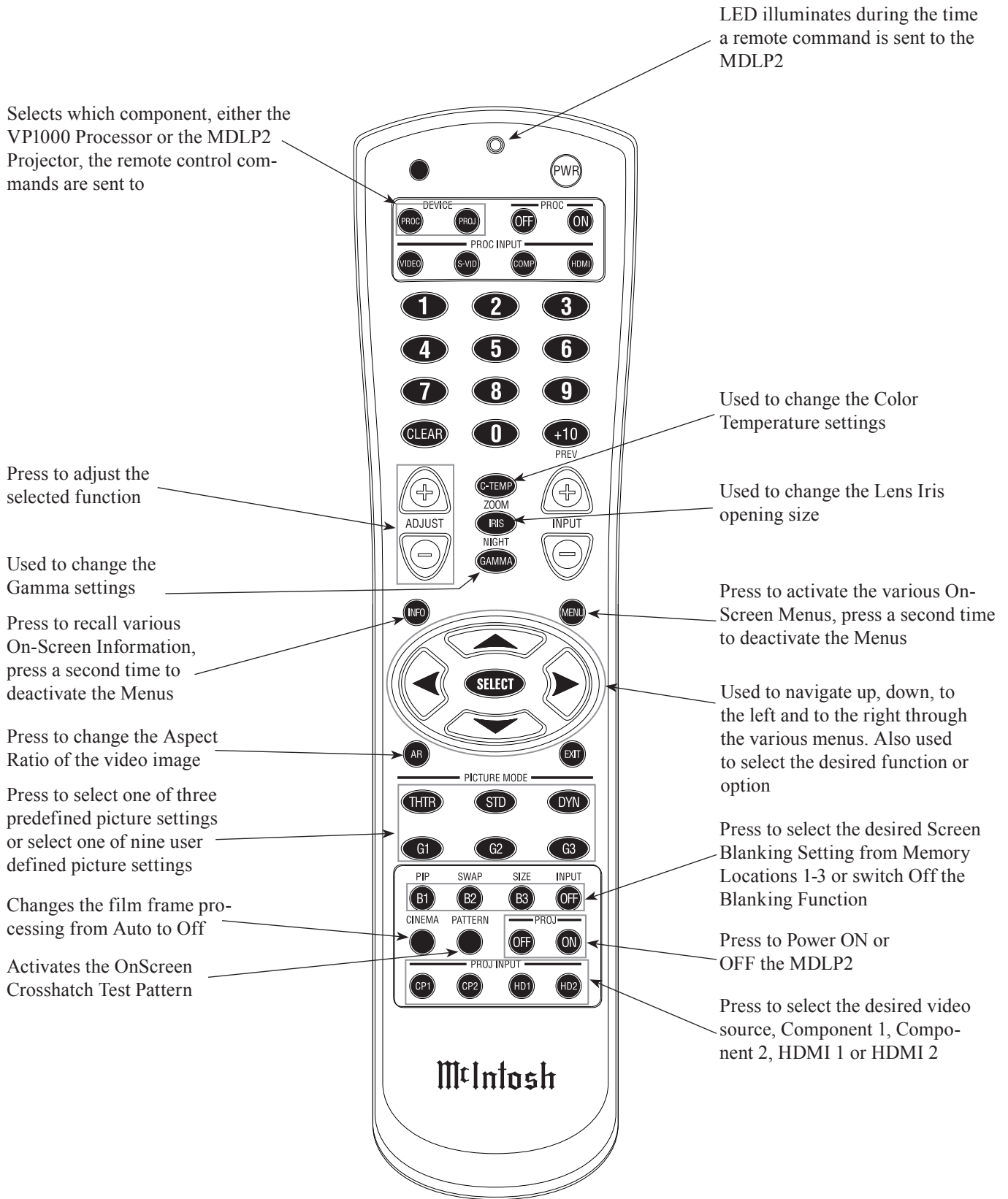

Note: Push-buttons whose function is not identified above are for use with other McIntosh Components

How to use the Remote Control

The supplied Remote Control is capable of directly controlling the functions of the McIntosh MDLP2 Video Projector and VP1000 Video Processor. For additional information on the various video adjustments and their purpose, please refer to the “How to Operate the MDLP2” section of this manual starting on page 22.

Note: At times it might appear the selected function is not responding when using the Remote Control. This can be due to the Input selected, the presence of a video signal for that input and the Picture Mode selected. Please refer to page 22 for additional information.

Device Selection

This Remote Control is used to operate the McIntosh MDLP2 Video Projector and the VP1000 Video Processor. When using the Remote Control with the MDLP2, first press the DEVICE PROJector push-button and then press the push-button for the desired function. It is only required to press the DEVICE PROJector push-button once, unless the Remote Control is also being used to control the VP1000 Video Processor.

When the Remote Control is being used to control both McIntosh Components, either the DEVICE PROCessor or the DEVICE PROJector push-button would need to be pressed first, before sending commands to the desired component.

Note: When any of the Push-buttons in the adjacent illustration are pressed, the Remote Control automatically switches to sending VP1000 Video Processor IR Codes.

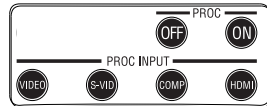

Power On

Press PROJector ON to switch the power On to the MDLP2.

Power Off

Press PROJector OFF to switch the power Off to the MDLP2.

Adjust Functions

After menu functions displaying a horizontal adjustment bar on the screen have been selected, such as Image Brightness, the ADJUST+ or ADJUST- push-buttons may be used to vary the brightness of the image.

Color Temperature

Allows for changing on the fly¹ the color neutrality of the image from warm thru cool (six different settings).

Iris

Allows for changing on the fly¹ the overall Image Brightness by varying the opening size of the Lens Iris (two different settings).

Gamma

Allows for changing on the fly¹ selected narrow segments of the gray scale, where the selected segment range of brightness/contrast is expanded (eight different segments).

Note: The term “Gray Scale” refers to the image intensity range from Black to White with shades of gray in-between.

Aspect Ratio

Allows for presenting the image with different height to width sizes. The choices available vary according to the original source material type, projector settings and input used.

Picture Modes

There are three preset modes THTR (Theater), STD (Standard) and DYN (Dynamic) along with three user group set selections, G1, G2 or G3. With every press of the G1 push-button a different User Setting will be selected (U1, U2 or U3). The G2 push-button will select (U4, U5 or U6) and the G3 push-button selects (U7, U8 or U9). Refer to “How to Operate the MDLP2” for additional information on using the User defined image settings.

Note: Changing the Picture Mode using the Remote Control Picture Mode Push-buttons will not occur if the On-Screen Menu is active. If the Menu is active, the Picture Mode may be changed using the Picture Mode Menu functions.

¹When some Picture Modes are selected, “the changing on the fly” feature is not available.

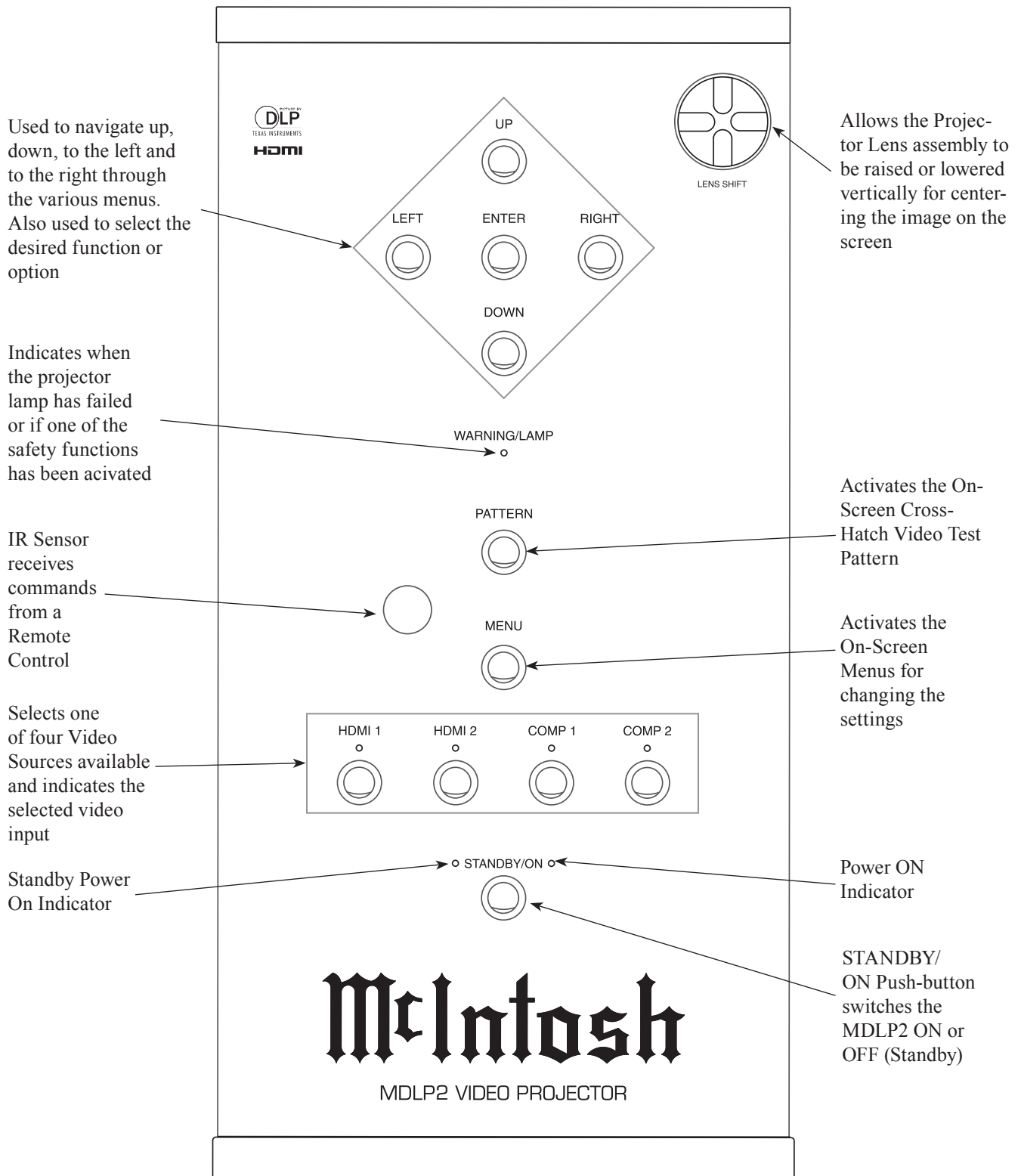

Default Settings

The Default Settings Charts indicate the On-Screen Menu Name, Function, Default Settings and the page number for additional information.

MENU	FUNCTION	SETTING	PAGE
Picture Mode	Theater	Default	24
	Standard (Default)	Default	24
	Dynamic	Default	24
	User	1	24
Picture Adjust	Gamma	Standard	24
	Contrast	0	24
	Brightness	0	24
	Color	0	24
	Tint	0	24
	Sharpness	0	24
	Color Temp.	3	24
	Lamp Mode	Normal	25
	Iris	3	25
Fine Menu 1	Noise Reduction	0	26
	R Gain	0	26
	G Gain	0	26
	B Gain	0	26
	R Bias	0	26
	G Bias	0	26
	B Bias	0	26
	Luminance Gain	0	26
	Chroma Delay	0	26
Fine Menu 2	Aspect	Full	26
	Cinema	Auto	26
	VCR Mode	Off	26
	Black Level	Normal	26
	FRC	Auto 1	26
	CEC	Off	26
	Picture Shift V	0	26
	Overscan	Enable	26
Input Signal	Component 1	Auto	27
	Component 2	Auto	27
	S-Video	Auto	27
	Video	Auto	27
	RGB	Auto	27
	HDMI 1	Auto	27
	HDMI 2	Auto	27

MENU	FUNCTION	SETTING	PAGE
RGB/HD Adjust	Mode	Auto	26
	Readjust	----	26
	Resolution H	0	26
	Resolution V	0	26
	Position H	0	26
	Position V	0	26
	Phase	0	26
	Clamp Position	0	26
	Clamp Width	0	26
HDMI	CSC HDMI 1	Auto	27
	CSC HDMI 2	Auto	27
	Deep Color HDMI 1	Auto	27
	Deep Color HDMI 2	Auto	27
Display	Keystone	0	27
	Scale	0	27
	Width	0	27
	Position H	0	27
	Position V	0	27
	Color Wheel	x5	27
	Installation	Front	27
OSD/Blanking	Menu Position	Top-L	27
	Language	English	27
	Status Info	Enable	28
	Power-Off Confirm	Disable	28
	Blanking Memory	Off	28
	Blanking Top	0	28
	Blanking Bottom	0	28
	Blanking Left	0	28
	Blanking Right	0	28
Config.	Auto Power Off	Disable	28
	Trigger 2 Full	On	28
	Trigger 2 Normal	On	28
	Trigger 2 Zoom	On	28
	Trigger 2 V-stretch	On	28
	Trigger 2 Through	On	28
	Remote Control	Wireless	28
	Reset Lamp Life	No	29
	Reset All	No	29



How to Operate the MDLP2

Power

The Red LED to the left of the STANDBY/ON Push-button lights to indicate the MDLP2 is in Standby mode. To Switch ON the MDLP2, press the STANDBY/ON Push-button on the Projector Control Panel or the Projector ON Push-button using the Remote Control. The Green LED to the right of the STANDBY/ON Push-button lights to indicate the MDLP2 is ON. Refer to figures 14 and 15.

Notes: 1. It is normal for the projector lamp warm up period to last about a minute before an image appears on the screen.

2. If the Initial Setup for the MDLP2 has not yet been performed refer to page 14 at this time.

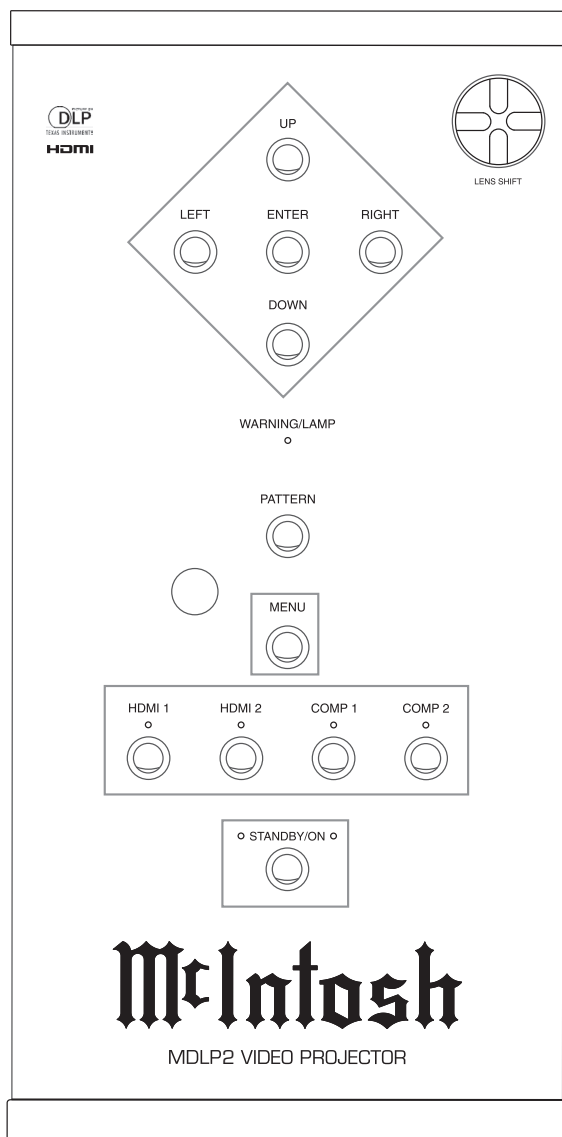

Figure 14

Source Selection

The default Source Select for the MDLP2 Projector is the COMPONENT 1 Input. There is an additional Component Video Input (COMP 2) along with two HDMI Inputs. Select the desired source using the push-buttons located on the Projector Control Panel or on the PROJ INPUT Push-buttons located on the Remote Control. Refer to figures 14 and 15.

Note: Whenever possible use HDMI connections between the source device output to the MDLP2 Input. This will yield better image quality, as the video signal will go through one less analog to digital conversion process and possibly one less digital to analog conversion process as well.

Image Adjustments and Setting changes

All of the electronic based image adjustments and processing settings are performed by using the extensive On-Screen Menu System. The On-Screen Menu System is interactive and the ability to change a given setting is dependent on the Input selected, the presence of a video signal for that input, the Picture Mode selected and are automatically saved for the currently selected video input. When a menu item is “grayed out” it can not be changed until either another Input is selected, a signal is present or a different Picture mode is selected.

The selection of a menu item and the available choices/adjustments are performed by using the Navigation (◀LEFT, ▶RIGHT, ▲UP or ▼DOWN) Push-buttons along with the ENTER/SELECT Push-buttons located on the Projector Control Panel and/or using the Remote Control Push-buttons.

The following examples will illustrate how to use the On-Screen Menu System by performing the Display Installation Orientation, Display Vertical Keystone Adjustment and Remote Control Configuration. All of the remaining menu options are performed in a similar manner.

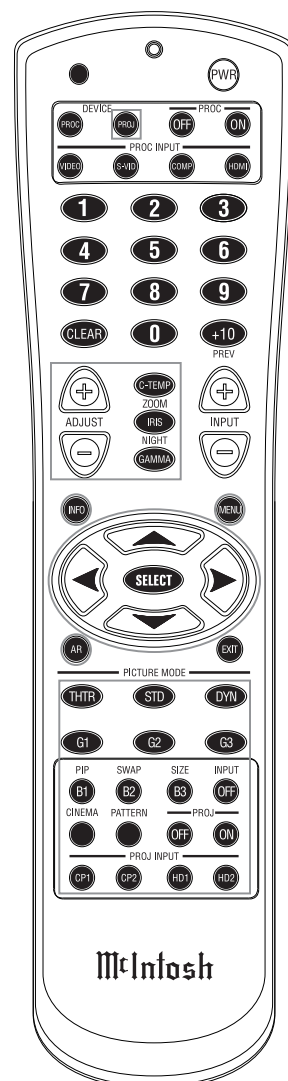

Figure 15

Display Installation Orientation:

1. Press the MENU Push-button on either the Projector Control Panel or on the Remote Control. Refer to figures 14 and 15.
2. Using the Navigation ▲UP or ▼DOWN Push-button, select DISPLAY from the Main Menu choices. Refer to figure 16.

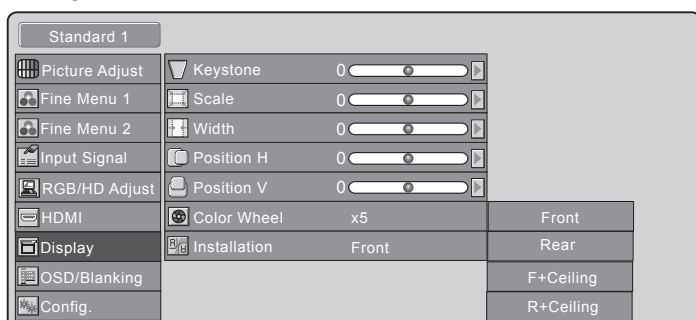

Figure 16

3. Using the Navigation ►RIGHT Push-button plus the ▲UP or ▼DOWN Push-button, select INSTALLATION from the Display Menu choices.
4. Press the Navigation ►RIGHT Push-button plus the ▲UP or ▼DOWN Push-button select the correct orientation of the projector relative to the screen. Refer to figure 17.

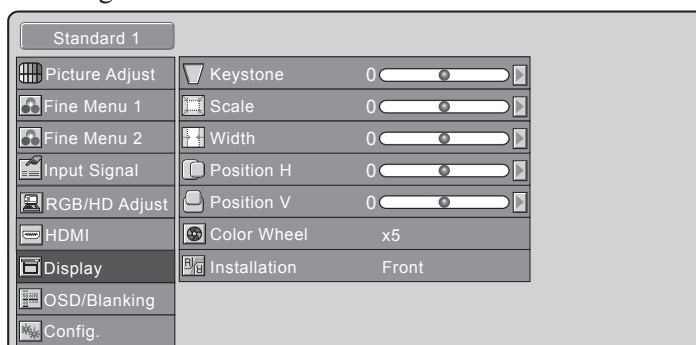

Figure 17

Vertical Keystone Adjustment:

1. Press the MENU Push-button on either the Projector Control Panel or on the Remote Control. Refer to figures 14 and 15.
2. Using the Navigation ▲UP or ▼DOWN Push-button, select DISPLAY from the Main Menu choices. Refer to figure 17.
3. Using the Navigation ►RIGHT Push-button plus the ▲UP or ▼DOWN Push-button, select KEYSTONE from the Display Menu choices.
4. Press the Navigation ►RIGHT Push-button and the On-Screen Display changes to show the video image selected plus a horizontal adjustment bar located near the bottom of the screen. Refer to figure 18.



Figure 18

5. Press the ◀LEFT or ▶RIGHT Navigation Push-button to adjust the image so the left and right vertical sides of the image are parallel to the sides of the screen. Refer to figures 19 and 20.

Note: The ADJUST + and - Push-buttons on the Remote Control may also be used.



Figure 19



Figure 20

In order to see the sides of the projected image, it might be necessary to temporarily reduce the size of the image by using the Lens Mechanical Size Adjustment. Refer to page 14. After the Vertical Keystone correction has been performed, the projected image might not fill up the screen. If necessary, use the Lens Mechanical Size Adjustment to correct.

Remote Control Configuration:

The MDLP2 has two built-in sensors, one on the front of the projector and the other sensor located on the Control Panel. In certain installations it might be desirable to use an external sensor connected to the IR Jack. If an external sensor is used, it is advisable to switch Off the built-in sensors to prevent possible interference. To switch Off these sensors perform the following steps on the next page:

1. Press the MENU Push-button on either the Projector Control Panel or on the Remote Control. Refer to figures 14 and 15.
2. Using the Navigation ▲UP or ▼DOWN Push-button, select CONFIG. from the Main Menu choices. Refer to figure 21.

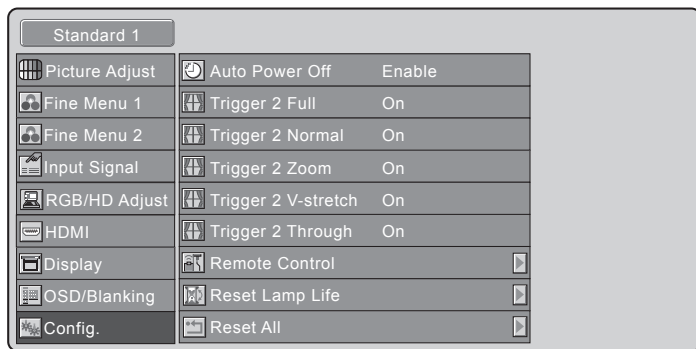

Figure 21

3. Using the Navigation ►RIGHT Push-button plus the ▲UP or ▼DOWN Push-button, select REMOTE CONTROL from the Config. Menu choices.
4. Press the Navigation ►RIGHT Push-button and the On-Screen Display changes to show a window. Refer to figure 22.
5. Press the ◀LEFT or ►RIGHT Navigation Push-button to select YES to disable the external sensors or NO to activate the internal sensors.
6. In order to activate the sensor choice, it is necessary to press the ENTER Push-button on the Control Panel.

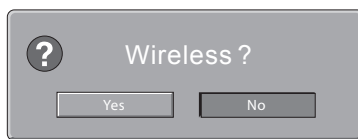

Figure 22

Note: The SELECT Push-button on the Remote Control will not activate the choice.

Picture Mode Selection

The MDLP2 has three predefined Picture Modes; Theater, Standard, Dynamic. There are also nine User definable Picture Modes. Refer to figure 23. A Picture Mode is a Memory Location that remembers the current image settings which are adjustable for the currently selected input.

There are two ways to select the Picture mode: selecting a mode from the On-Screen MENU or pressing the Picture Mode push-buttons (THTR, STD, DYN) on the Remote Control. To have the MDLP2 memorize the current setting perform the following:

1. Select a memory location (U1 thru U9) and then press the SELECT/ENTER Push-button.
2. Make the changes to the image using the menu system.

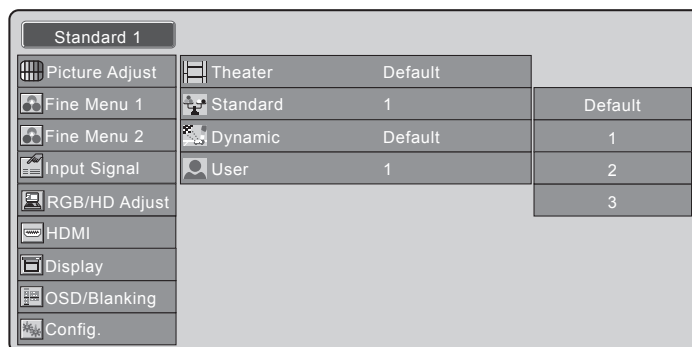

Figure 23

3. Reselect the memory location from step one and then press the SELECT/ENTER Push-button.

Picture Adjust Menu

There are various image adjustments available as follows: Refer to figure 24.

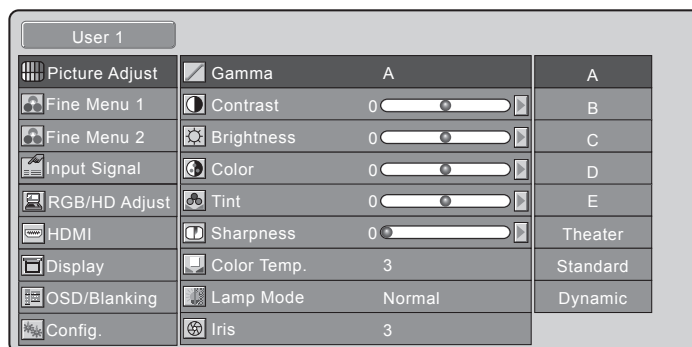

Figure 24

Gamma - There are eight different settings changing a narrow range of the gray scale.

Color Temp. - The Color Temperature affects to what degree of neutrality the gray scale is.

Setting - Color Temperature (° Kelvin)

- 1 5250° K (overall reddish tint)
 - 2 5800° K (slightly overall reddish tint)
 - 3 6500° K (most neutral, default setting)
 - 4 7500° K (slightly overall bluish tint)
 - 5 9300° K (overall bluish tint)
- HB** High Bright (Display brightest image)

Lamp Mode - The Normal setting provides a brightly illuminated image with reasonable projector lamp life. The Economy setting has slightly reduced illumination with an increase in lamp life.

Iris - The settings effect the overall image brightness and contrast. The “1” setting will increase the contrast and decrease the brightness of the image. The “3” setting will decrease the contrast and increase the brightness of the image.

Fine Menu 1 Adjust

In the Fine Menu 1 there are two user type adjustments, image sharpness and noise reduction. The remaining adjustments are best performed by a professional with the necessary video signal generators and optical measurement equipment. Refer to figure 25.

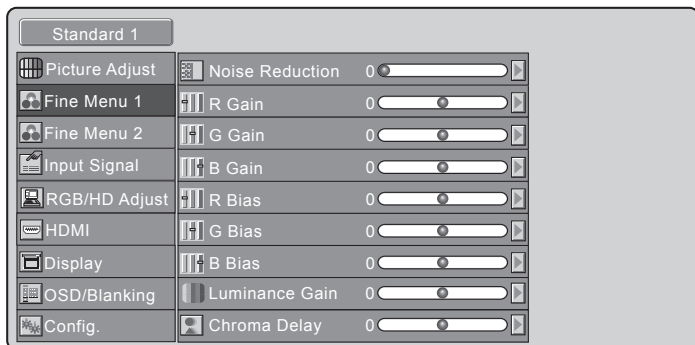

Figure 25

Noise Reduction - Reduces the amount of electronic noise present in the video signal.

R Gain - This menu allows setting the gain for red.

G Gain - This menu allows setting the gain for green.

B Gain - This menu allows setting the gain for blue.

R Bias - This menu allows setting the bias for red.

G Bias - This menu allows setting the bias for green.

B Bias - This menu allows setting the bias for blue.

Note : The settings made in Fine Menu 1 are saved in the currently selected Picture Mode (Default excluded).

Luminance Gain - This menu allows the users to set the luminance gain.

Chroma Delay - This menu allows the users to set the chrominance delay.

Fine Menu 2 Adjust

The following adjustment are intended to be use by a professional installer to compensate for differences in video signals from various sources. Refer to figure 26.

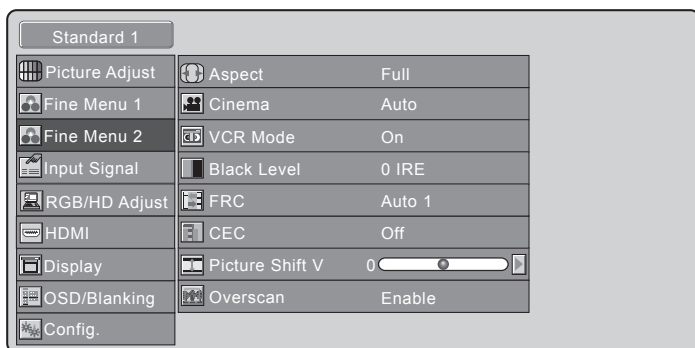

Figure 26

Aspect - Allows for changing the projected image size height to width ratio to compensate for the different image sizes from various sources materials such as film and TV video. Refer to figure 27 on the next page.

Cinema - Auto: Automatically selects the cinema mode when a video signal is input. NTSC: 3-2 pull down, PAL: 2-2 pull down.

Off: Pull-down processing is not performed.

VCR Mode - On: A projector is forced into the intra-field only deinterlacing mode.

Off: A projector is used with external field memories and operates in the full set of deinterlacing modes, i.e., motion adaptive video deinterlacing and full frame film source deinterlacing using 3:2 pull-down detection (2:2 pulldown for 625/50 sources).

Black level - Select the black level by a video source.

FRC - Auto: Frame Rate Conversion function is basically off. However FRC turns on automatically depending on vertical frequency of input signal.

On: Frame Rate Conversion function is On (60Hz fixed).

CEC - On: Chroma Error Correction reduces CUE (Chroma Up-sampling Error) of 1080i signals.

Off : Normally, use this mode.

Picture Shift V - When Aspect on the Picture Adjust menu is set to Zoom, this setting allows the user to move the projected image vertically in order to see parts on the image not appearing on the screen.

Overscan - Selects whether to show or hide picture borders with SD (Standard Definition) video signals.

Input Signal Resolution Selection

There are several SD (Standard Definition) and HD (High Definition) types of video signals the MDLP2 is capable of displaying. The default setting for the Component Video and HDMI Inputs of the MDLP2 is AUTO. In the AUTO Mode, the MDLP2 will automatically switch to the highest resolution possible for each of the video signals it receives. Refer to figure 28 on the next page.

Note: The S-Video, Video and RGB Inputs are not used on the MDLP2.

Item	Resolution Selection
Component 1 and 2	Auto, 480i/576i, 480p, 540p, 576p, 720p, 1035i, 1080i, 1080p
HDMI 1 and 2	Auto, 480i/576i, 480p, 576p, 720p, 1035i, 1080i, 1080p

ASPECT RATIO OPTIONS				
	16:9 VIDEO SOURCE		4:3 VIDEO SOURCE	
MODE	IMAGE	DESCRIPTION	IMAGE	DESCRIPTION
INPUT SIGNAL (HDMI, 1080p signal)		The Image Source Aspect Ratio is 1.78:1		The Image Source Aspect Ratio is 1.33:1
FULL		The 16:9 image is displayed with the correct aspect		The 4:3 image is enlarged horizontally
NORMAL		The picture in normal ratio 16:9 is displayed		The picture in normal ratio 4:3 is displayed
ZOOM		Both the vertical and horizontal components are enlarged		Both the vertical and horizontal components are enlarged
V-STRETCH		The vertical component of the aspect ratio is elongated		The vertical component of the aspect ratio is elongated
THROUGH		Images are actual pixel size		Images are actual pixel size

Figure 27

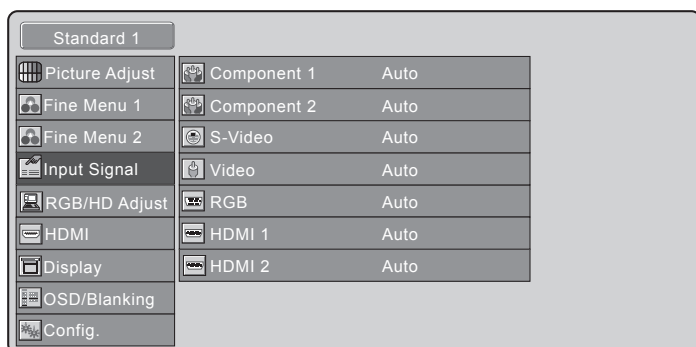

Figure 28

RGB/HD Adjust

The RGB/HD allow for fine adjustments to be made to HD (High Resolution) Video Signals. Refer to figure 29.

Mode - Auto: Automatically adjusts each of the RGB/HD Menu items.

Memory: Allows for manual adjustments of the 1-3 RGB/HD Menu items and the adjustments can be stored in one of three memory locations.

Resolution H, V - Adjusts the horizontal and vertical resolution of the RGB/HD input signals.

Position H, V - Adjusts the position of the input signal. H adjusts the horizontal position of the input signal. V adjusts the vertical position of the

input signal. The remaining adjustments are for RGB signals and are thus “grayed out”.

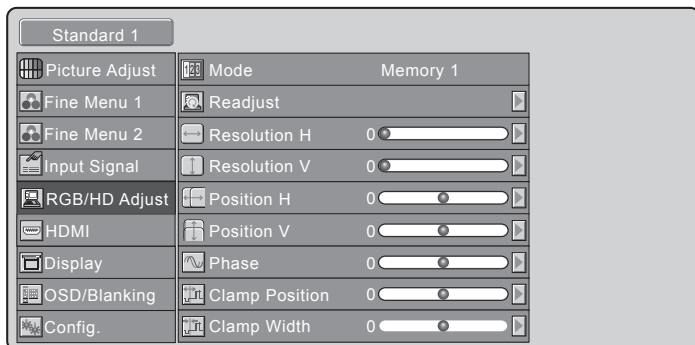

Figure 29

HDMI Menu Adjust

The HDMI Menu provides adjustments for matching the Color Space and Deep Color settings of the MDLP2 to the source component. Refer to figure 30.

CSC HDMI 1/2 - The Default setting is AUTO, however there are several manual settings in the event the source component is unable to communicate the desired setting.

Deep Color HDMI 1/2 - The Default setting is AUTO, however there are several manual settings in the event the source component is unable to communicate the desired setting.

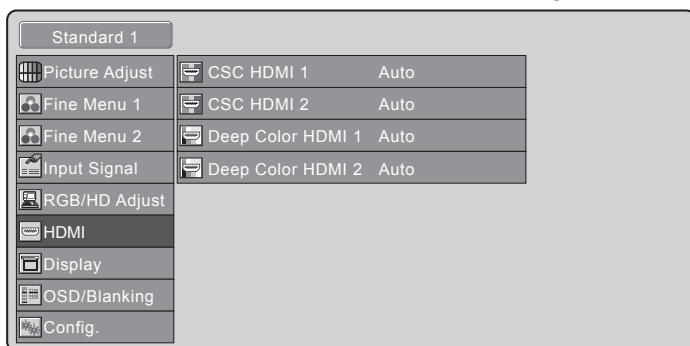

Figure 30

Display Menu Adjust

The Display Menu allows for electronic adjustments to be made to the image to compensate for orientation of the projector relative to the screen. Refer to figure 31.

Note: Before using the electronic adjustments, make sure all of the Initial Setup Mechanical Adjustments have been made first. Refer to pages 14 and 15.

Keystone - Refer to “Vertical Keystone Adjustment” on page 23.

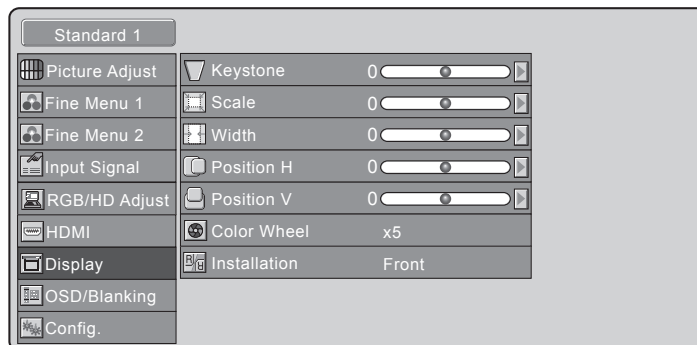

Figure 31

Scale - Reduces the image size without changing the aspect ratio. The image can be reduced to about 70% of the original size.

Width - Reduces the image width without changing the image height. The width can be reduced to about 75% of the original size.

Position H, V - Adjust the position of the input signal. H adjusts the horizontal position of the input signal. V adjusts the vertical position of the input signal.

Enable: Default mode.

Disable: Reduces the size of the image so the edges of the video signal can be seen.

Color Wheel - Sets the rotation speed of the lamp source color optical filter. x5 is the default setting.

Note: The on-screen image will momentarily disappear during the speed change.

Installation - Refer to “Display Installation Orientation” on page 23.

OSD/Blanking

The OSD (On-Screen Display) and Blanking Adjustments default settings may be changed for personal preferences. Refer to figure 32.

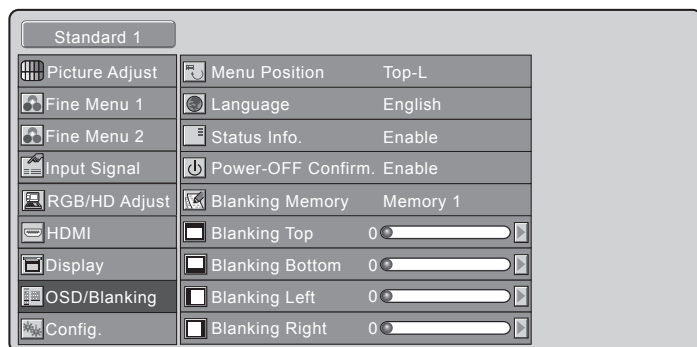

Figure 32

Menu Position - There are nine different positions On-Screen to display the menus.



Status Info. - Displays On-Screen information about the status of the video input signal and when other operational modes are selected. This occurs when the INFO Push-button or other push-buttons are pressed on the Remote Control.

Enable: Displays the current status for a set amount of time in the upper right-hand corner of the screen.

Disable: The information is not displayed.

Power-OFF Confirm - Displays an On-Screen message requesting confirmation after pressing either the PROJ OFF Push-button on the Remote Control or the STANDBY/ON Push-button on the Projector Control Panel (as the push-button may have been pressed by mistake).

Disable: Switches Off power to the projector without the option provided by the confirmation message.

Enable: The confirmation message will appear after pressing either push-button to switch power Off to the projector.

Blanking Memory - There are three memory locations capable of storing how much projected image (top/bottom/sides) will be cut off by black bands (masking) to prevent viewing the undesirable parts of the image.

Memory 1-3: Each of the three memory locations will store and retrieve the desired masking settings.

Off: Switches Off the blanking mode. No masking occurs.

Config. Settings

The items in the configuration menu determine how the MDLP2 Projector interfaces with other equipment, such as motorized projection screens. There are also settings dealing with the MDLP2 Projection Lamp. Refer to figure 33 and your McIntosh Dealer for additional information and/or assistance.

Auto Power Off - This feature allows for the MDLP2 to be switched Off automatically ten minutes

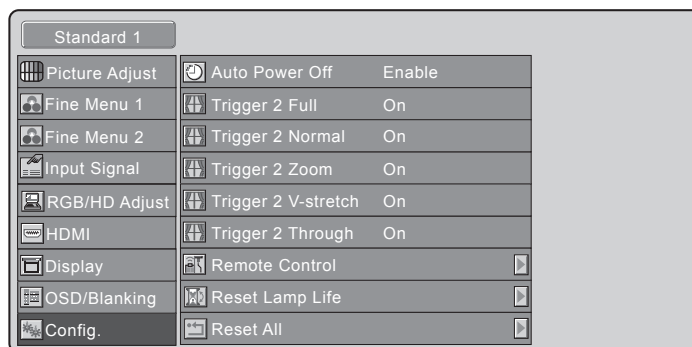

Figure 33

after there is a loss of a video signal on the currently selected input, thus conserving the projector's lamp life.

Enable: This setting will activate the feature. Approximately nine minutes after there is a loss of the video signal, an On-Screen message will appear. If the MDLP2 doesn't receive a video signal on the currently selected input or a new command is not issued via the Control Panel or Remote Control, the MDLP2 will switch Off about one minute later. Refer to figure 34.

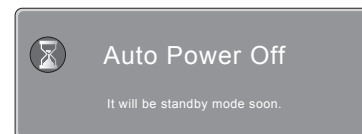

Figure 34

Disable: The Auto Power Off Feature is switched Off.

Trigger 2 - Is activated by changing the Aspect Ratio (Full, Normal, Zoom, V-stretch and Through). This allows for changing the size of the reflective area of the projection screen (via motorized masking) and/or the addition of an external lens in the light path. With a given Trigger 2 (Full, Normal, Zoom, V-stretch and Through) set to ON, a 12VDC output will appear at the Trigger 2 Output Jack; when set to OFF, 0V appears at Trigger 2 Output Jack.

Remote Control - Selection includes the two built in sensors along with any external sensor(s) connected via the external IR Input Jack or just external sensor(s). Refer to page 5, General Information Note 6.

Wireless: Selects external sensor(s) only.
 Wired: Selects the two internal sensors and any external sensor(s) connected to the MDLP2.

Note: When making a change to the current menu setting, the ENTER Push-button on the MDLP2 Control Panel must be used to effect the desired change.

Reset Lamp Life - The projection lamp used in the MDLP2 has a maximum life expectancy of 2,000 hours.

If at any time you would like to know how many hours of use are left for the lamp, press the INFO Push-button on the Remote Control and the On-Screen Display will appear indicating the number of hours remaining. Refer to figure 35.

Information	
Video Input	HDMI 1 - 1080p
Picture Mode	User 1
Gamma	A
Aspect	Normal
Lamp Mode	Economy
Iris	3
Lamp Life	921 Hours
Total Time	3653 Hours

Figure 35

When there is approximately 100 hours of lamp life remaining, an On-Screen Warning Message will appear briefly. Refer to figure 36.

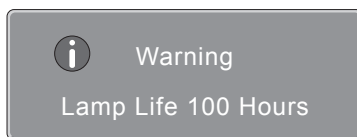

Figure 36

If you have chosen not to replace the lamp at this time, a second warning message will appear with approximately 5 hours remaining. Refer to figure 37.

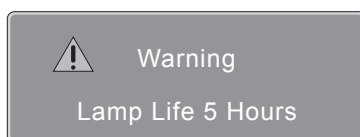

Figure 37

Finally, the last warning message will appear On-Screen, the MDLP2 Projector will shut Off and the Control Panel WARNING/LAMP LED will illuminate red. Refer to figure 38.

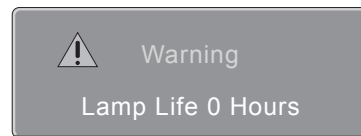

Figure 38

After your McIntosh Dealer has replaced the Projector Lamp, check to make sure the Lamp Life has been reset by pressing the INFO Push-button on the Remote Control. The On-Screen Display should indicate 2,000 hours. If it was not reset, please do so at this time by selecting the Reset Lamp Life from the On-Screen Menu. Then select YES and press the ENTER Push-button. Refer to figure 39.

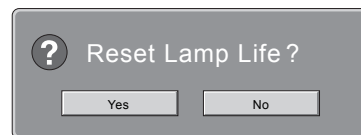

Figure 39

Reset All - If it becomes necessary to reset all the menu settings back to factory defaults (except for the Lamp Life Setting), select the Reset All from the On-Screen Menu and then select YES and press the ENTER Push-button. Refer to figure 40.

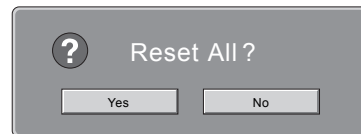

Figure 40

Reset of Microprocessors

In the unlikely event the controls of the MDLP2 stop functioning, the microprocessors can be reset by disconnecting the AC Power Cord from the MDLP2, waiting for 5 minutes and then reconnecting the AC Power Cord.



Optical Specifications

Digital Micromirror Device

0.95 inch (16:9)
1920 x 1080 pixels

Lamp

Super High Pressure 200W DC

Lens

f: 30.7 – 44.5mm (medium throw lens)
f: 44.5 – 66.75mm (long throw lens)
F: F3.0/F6.0

Projected Image Size

70 to 250 inches (medium throw lens, 1.77:1 aspect ratio)
80 to 300 inches (long throw lens, 1.77:1 aspect ratio)
70 to 250 inches (medium throw lens, 1.33:1 aspect ratio)
60 to 300 inches (long throw lens, 1.33:1 aspect ratio)

Electrical Specifications

Video Inputs

2 - Component Analog Video (Y, Pb, Pr)
2 - HDMI Digital Video (1.3 Compliant)

McIntosh Data Control Input

1- 1/8 inch Stereo Mini Jack

Power Control In

1 - 1/8" Stereo Mini Jack
Input voltage range 5V – 12V

Power Control Out

1- 1/8" Stereo Mini Jack
Output voltage 5V

Trigger Outputs

2- 1/8" Stereo Mini Jacks
Output Voltage 0V or 12VDC

Data Communications

Standard RS-232C
9pin D-Subminiature female receptacle

Power Requirements

100 Volts, 50/60Hz at 350 watts
110 Volts, 50/60Hz at 350 watts
120 Volts, 50/60Hz at 350 watts
220 Volts, 50/60Hz at 350 watts
230 Volts, 50/60Hz at 350 watts
240 Volts, 50/60Hz at 350 watts

Note: Refer to the rear panel of the MDLP2 for the correct voltage.

General Specifications

Operating Temperature

41 to 95°F
5 to 35°C

Operating Humidity

30 to 85%

Overall Dimensions

Width is 20-1/4 inches (51.44cm)
Height is 6- 3/4 inches (17.15cm) feet retracted
Height is 9- 1/2 inches (24.13cm) feet extended
Depth is 18- 13/16 inches (47.78cm) medium throw lens
Depth is 19- 1/16 inches (48.41cm) long throw lens

Weight

40 pounds (18.14 kg) net, 54 pounds (24.5 kg) in shipping carton

Shipping Carton Dimensions

Width is 32 inches (81.28cm)
Depth is 28 inches (71.12cm)
Height is 13 inches (33.02cm)

Packing Instructions

In the event it is necessary to repack the equipment for shipment, the equipment must be packed exactly as shown on this page, with the protective cover installed on the projector lens. Failure to do this will result in shipping damage.

Use the original shipping carton and interior parts only if they are all in good serviceable condition. If a shipping carton or any of the interior part(s) are needed, please call or write the Customer Service Department of McIntosh Laboratory. Refer to page 4. Please see the Part List for the correct part numbers.

CAUTION: To prevent possible damage to the Projector Lens Assembly, DO NOT at any time attempt to LIFT, CARRY or RE-ORIENT the Projector using the Lens.

<u>Quantity</u>	<u>Part Number</u>	<u>Description</u>
1	034374	Shipping carton complete

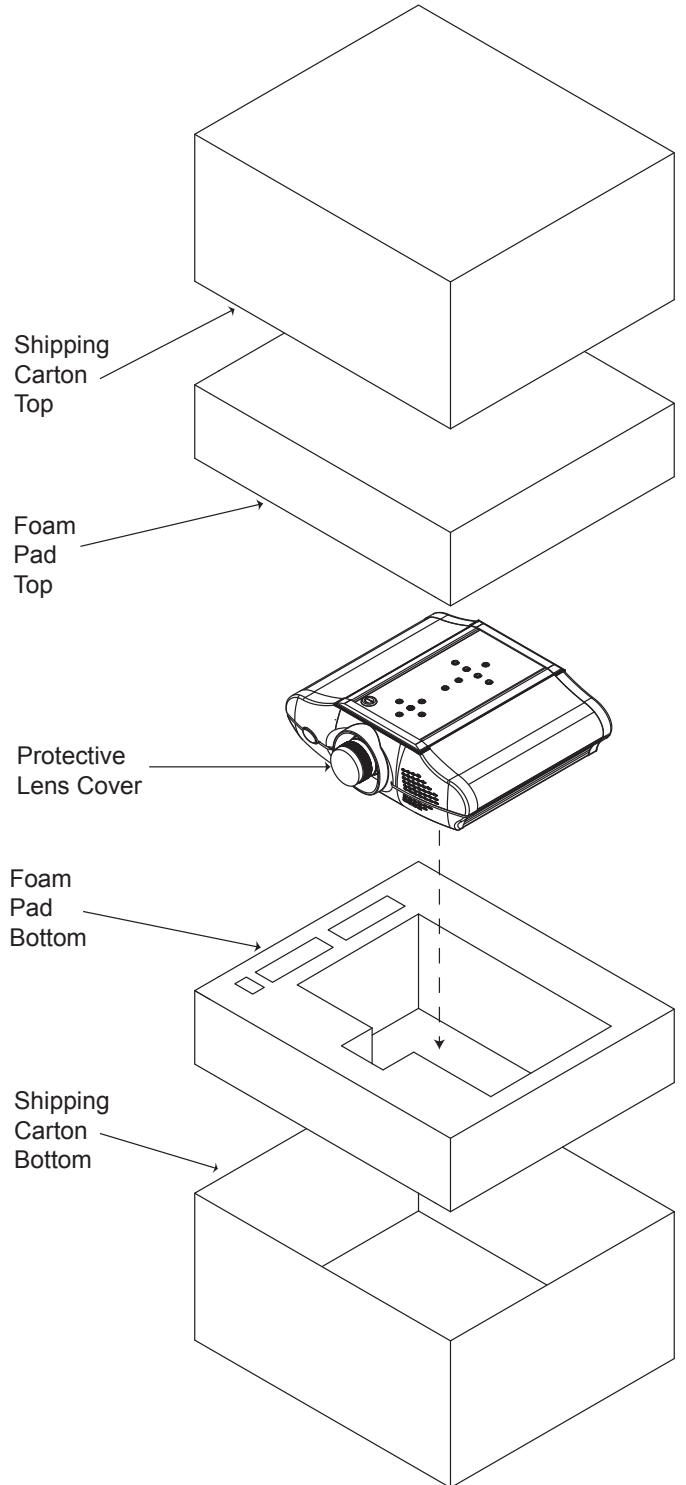



McIntosh Laboratory, Inc.
2 Chambers Street
Binghamton, NY 13903
www.mcintoshlabs.com

The continuous improvement of its products is the policy of McIntosh Laboratory Incorporated who reserve the right to improve design without notice. Printed in the U.S.A.